

Contents

Dear Customers	2
Preliminary Remarks	2
Precautions	2
Parts Identification.....	3
Symbols	4
Operation Mode	5
1. Normal Measurement With Storing Data.....	5
2. Recalling Data.....	5
3. Clearing Data.....	5
4. Measurement With The Desired Systolic Pressure.....	5
Using The Monitor	6
Installing / Changing The Batteries	6
Connecting The Air Hose.....	6
Adjusting The Built-in Clock	7
Setting Three Reminders	7
Alarm ON/OFF Mark On The Display	8
Attaching The Arm Cuff.....	8
How To Take Proper Measurements	8
Measurement.....	8
After Measurement	8
Measurements	9
Normal Measurement	9
Measurement With The Desired Systolic Pressure.....	10
Notes For Proper Measurement	10
Recalling Memory Data	11
What Is An Irregular Heartbeat	12
Pressure Bar Indicator.....	12
WHO Classification Indicator	12
About Blood Pressure	13
What Is Blood Pressure?.....	13
What Is Hypertension And How Is It Controlled?.....	13
Why Measure Blood Pressure At Home?.....	13
WHO Blood Pressure Classification	13
Blood Pressure Variations	13
Troubleshooting	14
Maintenance	15
Technical Data	15

Dear Customers

Congratulations on purchasing a state-of-the-art A&D blood pressure monitor, one of the most advanced monitors available today. Designed for ease of use and accuracy, this monitor will facilitate your daily blood pressure regimen.

We recommend that you read through this manual carefully before using the device for the first time.

Preliminary Remarks

- ┘ This device conforms to the European Directive 93/42 EEC for Medical Products. This is made evident by the **CE**₀₃₆₆ mark of conformity. (0366: The reference number to the involved notified body)
- ┘ The device is designed for use on adults only, not newborns or infants.
- ┘ Environment for use
The device is for use indoors.

Precautions

- ┘ Precision components are used in the construction of this device. Extremes in temperature, humidity, direct sunlight, shock or dust should be avoided.
- ┘ Clean the device with a soft, dry cloth. Never use thinner, alcohol, benzene, or wet cloth.
- ┘ Avoid tightly folding the cuff or storing the hose tightly twisted for long periods, as such treatment may shorten the life of the components.
- ┘ The device and cuff are not water resistant. Prevent rain, sweat and water from soiling the device and cuff.
- ┘ Measurements may be distorted if the device is used close to televisions, microwave ovens, cellular telephones, X-ray or other devices with strong electrical fields.
- ┘ Used equipment, parts and batteries are not treated as ordinary household waste, and must be disposed of according to the applicable local regulations.



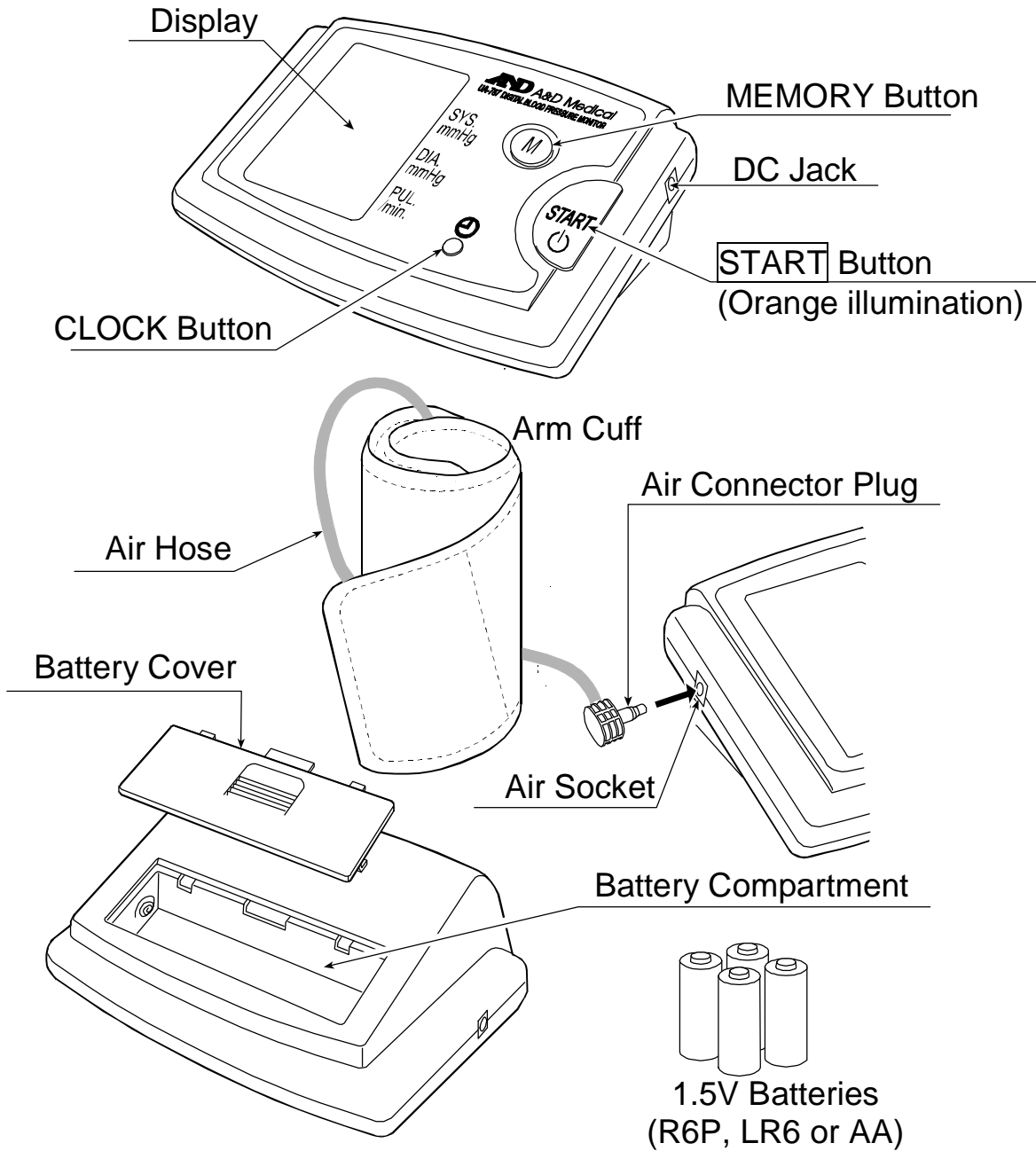







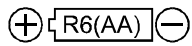



Parts Identification



Part of Display

	MEMORY		Systolic Pressure
Pressure Bar Indicator and WHO Classification Indicator		SYS. mmHg	Diastolic Pressure
	Heart Mark	DIA. mmHg	Pulse Rate
I.H.B. Indicator (Irregular heartbeat indicator)		PUL. /min.	Battery Indicator

Symbols

Symbols	Function / Meaning	Recommended Action
	Standby and Turn the device on.	_____
	Battery installation guide	_____
	Direct current	_____
SN	Serial number	_____
2005 	Date of manufacture	_____
	Type BF: Device, cuff and tubing are designed to provide special protection against electrical shocks.	_____
	The indicator while measurement is in progress. It blinks while detecting the pulse.	Measurement is in progress. Remain as still as possible.
	Irregular Heartbeat indicator. (I.H.B.) The indicator that detects irregular heartbeats or any excessive body movement during the measurement.	_____
M	Previous measurements stored in MEMORY.	_____
 Full Battery	The battery power indicator during measurement.	_____
 Low Battery	The battery is low when it blinks.	Replace all batteries with new ones, when the indicator blinks.
Err	Unstable blood pressure due to movement during the measurement.	Try measurement again. Remain very still during the measurement.
	The systolic and diastolic values are within 10 mmHg of each other.	Fasten the cuff correctly, and try the measurement again.
	The pressure value did not increase during inflation.	
	The cuff is not fastened correctly.	Fasten the cuff correctly, and try the measurement again.
	The pulse is not detected correctly.	
SYS	Systolic blood pressure in mmHg	_____
DIA	Diastolic blood pressure in mmHg	_____
PUL./min	Pulse per minute	_____
	CLOCK button mark	If you want to stop the sound, press the START button.
	Alarm ON/OFF mark of the reminder	
	EC directive medical device label	_____
	WEEE label	_____

Operation Mode

1. Normal Measurement With Storing Data *(Refer to page 9)*

Press the **START** button. Blood pressure is measured and data is stored within the device. The device can store the last sixty sets of data in memory automatically.

2. Recalling Data *(Refer to page 11)*

Press the MEMORY button to recall the data. The date and the most recent data are displayed.

The device can store the last sixty sets of data in memory automatically.

Press the MEMORY button

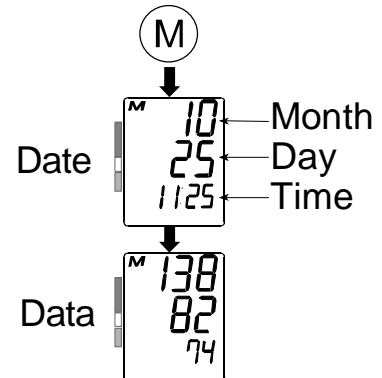

3. Clearing Data *(Refer to page 11)*

Press and hold the MEMORY button until the “M” (memory) mark blinks to clear the stored data.

4. Measurement With The Desired Systolic Pressure

Refer to page 10 for the measurement with the desired systolic pressure.



Using The Monitor

Installing / Changing The Batteries

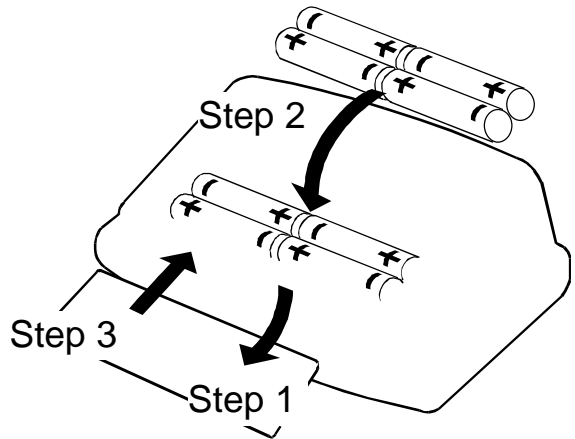
1. Slide the battery cover up to open it.
 2. Remove the used batteries and insert new batteries into the battery compartment as shown, taking care that the polarities (+) and (-) are correct.
 3. Slide the battery cover down to close it.
- Use only R6P, LR6 or AA batteries.



CAUTION

- ┘ Insert the batteries as shown in the battery compartment. If not, the device will not work.
- ┘ When  (LOW BATTERY mark) blinks in the display, replace all batteries with new ones. Do not mix old and new batteries. It may shorten the battery life, or cause the device to malfunction.
- ┘  (LOW BATTERY mark) does not appear when the batteries are drained.
- ┘ Battery life varies with the ambient temperature and may be shorter at low temperatures.
- ┘ Use the specified batteries only. The batteries provided with the device are for testing monitor performance and may have a limited life.
- ┘ Remove the batteries if the device is not to be used for a long time. The batteries may leak and cause a malfunction.
- ┘ Stored data are cleared when the batteries are removed.

Connecting The Air Hose

Insert the air connector plug into the air socket firmly.

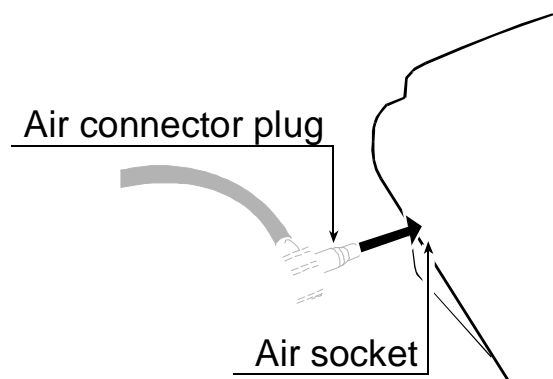

Using The Monitor

Adjusting The Built-in Clock

The monitor has a built-in clock. We recommend that you adjust the clock prior to use.

1. Press and hold the CLOCK button until the digits start blinking.
2. Select the year using the **START** button.
Press the CLOCK button to set the current year and move to month/day selection. The date can be set anywhere between the years 2004 and 2053.
3. Select the month using the **START** button.
Press the CLOCK button to set the current month and move to day selection.
4. Select day using the **START** button.
Press the CLOCK button to set the current day and move to hour/minute selection.
5. Select hour using the **START** button.
Press the CLOCK button to set the current hour and move to minute selection.
6. Select minute using the **START** button.
Press the CLOCK button to set the current minute and activate the clock.

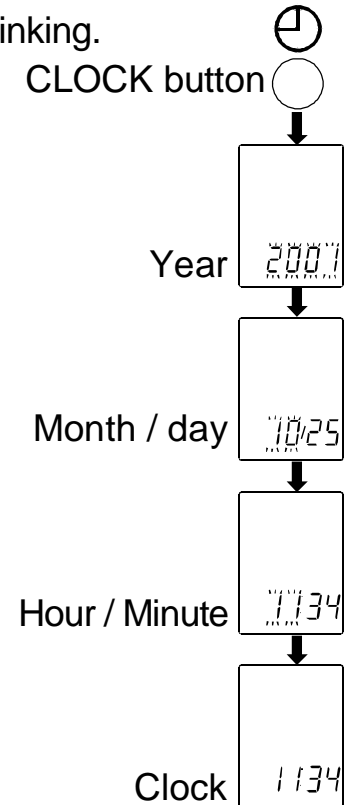

Setting Three Reminders

This monitor has 3 reminder alarms. You can set 3 different reminder alarms within a 24-hour period.

1. Press and hold the CLOCK button until the digits start blinking. Then press the MEMEORY button. "P-1" is shown at the middle line of the display.
2. Select hour using the **START** button and press the CLOCK button to set the hour and move to minute selection. Press the MEMEORY button to complete the reminder setting after selecting minute.
3. Then the display shows "P-2" for the second reminder. Repeat the above process if you need a second reminder.
4. A third reminder can be set as well.

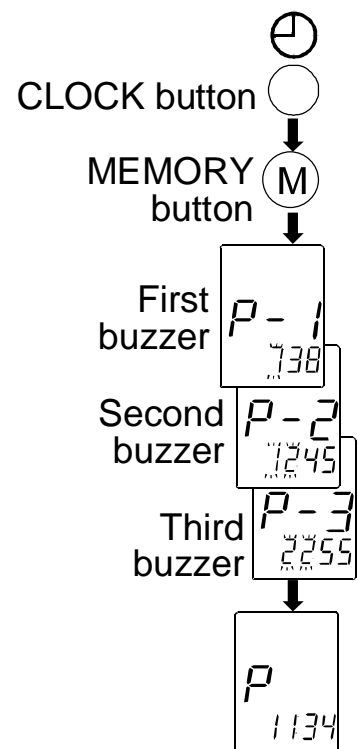

Using The Monitor

Alarm ON/OFF Mark On The Display

When the alarm is on, a “p” appears on the LCD display. To turn the alarm off, simply press the CLOCK button once.

The alarm will sound for 1 minute. To turn off the alarm, press the **START** button once.

Attaching The Arm Cuff

1. Wrap the cuff around the upper arm, about 2-3 cm above the elbow, as shown. Place the cuff directly against the skin, as clothing may cause a faint pulse, and result in a measurement error.
2. Constriction of the upper arm, caused by rolling up a shirtsleeve, may prevent accurate readings.

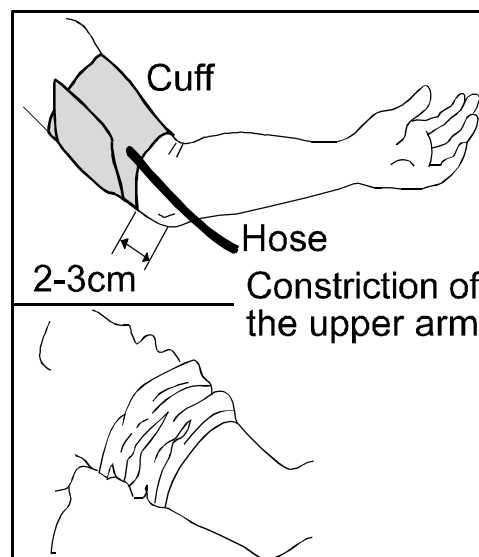

How To Take Proper Measurements

For the most accurate blood pressure measurement:

- ┘ Sit comfortably around the table. Rest your arm on the table.
- ┘ Relax for about five to ten minutes before measurement.
- ┘ Place the center of the cuff at the same height as your heart.
- ┘ Remain still and keep quiet during measurement.
- ┘ Do not measure right after physical exercise or a bath. Rest for twenty or thirty minutes before taking the measurement.
- ┘ Try to measure your blood pressure at the same time every day.

Measurement

During measurement, it is normal for the cuff to feel very tight. (Do not be alarmed).

After Measurement

After measurement, press the **START** button to turn off the power. Remove the cuff and record your data.

Note: The device has an automatic power shut-off function, which turns the power off automatically one minute after measurement.

Allow at least ten minutes between measurements on the same person.

Measurements

Model UA-787 *Plus* is designed to detect the pulse and to inflate the cuff to a systolic pressure level automatically.

If your systolic pressure is expected to exceed 230 mmHg or you use the optional small cuff, read "Measurement With The Desired Systolic Pressure" on next page.

Normal Measurement

1. Place the cuff on the arm (preferably the left arm).
Sit quietly during measurement.

2. Press the **START** button.
The average blood pressures and last data number are displayed briefly. Then the display changes, as indicated in the figure at the right, as the measurement begins. The cuff starts to inflate. It is normal for the cuff to feel very tight. A pressure bar indicator is displayed, as in the figure at the right, during inflation.

Note: If you wish to stop inflation at any time, press the **START** button again.

3. When inflation is complete, deflation starts automatically and ♥ (heart mark) blinks, indicating that the measurement is in progress. Once the pulse is detected, the mark blinks with each pulse beat.

Note: If an appropriate pressure is not obtained, the device starts to inflate again automatically.

4. When the measurement is complete, the systolic and diastolic pressure readings and pulse rate are displayed. The cuff exhausts the remaining air and deflates completely.

5. Press the **START** button again to turn off the power.

Note: Model UA-787 *Plus* is provided with an automatic power shut-off function. Allow at least ten minutes between measurements on the same person.

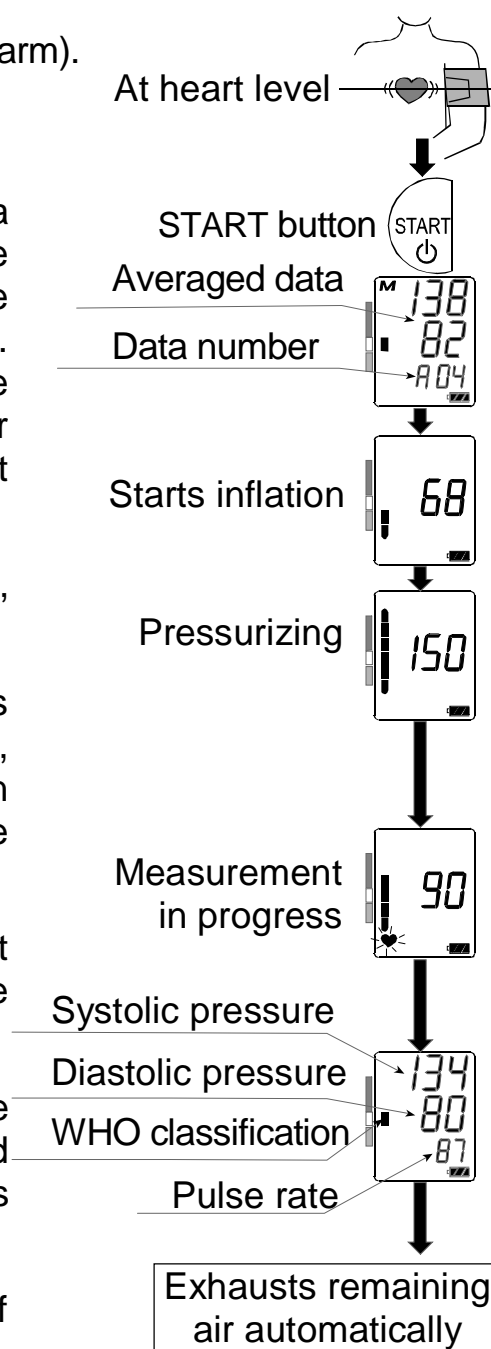

Measurements

Measurement With The Desired Systolic Pressure

If your systolic pressure is expected to exceed 230 mmHg or you use the optional small cuff, use this procedure.

1. Place the cuff on the arm (preferably the left arm).
2. Press and hold the **START** button until a number about 30 to 40 mmHg higher than your expected systolic pressure appears.
3. Release the **START** button to start measurement, when the desired number is reached. Then continue to measure your blood pressure as described on the previous page.

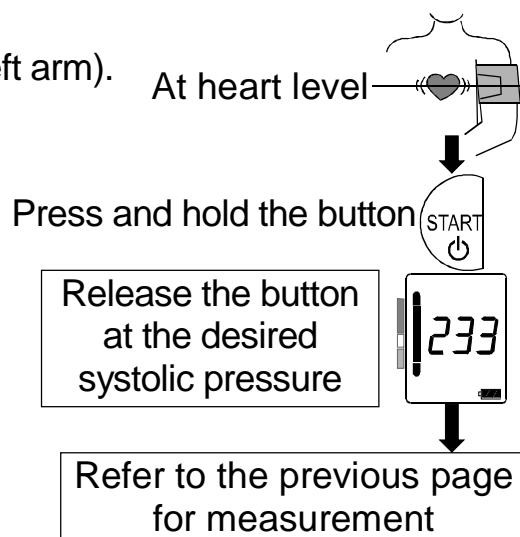

Notes For Proper Measurement

- ┌ Sit down in a comfortable position. Place the arm to be used for the measurement on a table or other support so that the center of the cuff will be at the same height as your heart.
- ┌ Relax for about five or ten minutes before taking a measurement. If you are excited or depressed by emotional stress, the measurement will reflect this stress as a higher (or lower) than normal blood pressure reading and the pulse reading will usually be faster than normal.
- ┌ An individual's blood pressure varies constantly, depending on what you are doing and what you have eaten. What you drink can have a very strong and rapid effect on your blood pressure.
- ┌ This device bases its measurements on the heartbeat. If you have a very weak or irregular heartbeat, the device may have difficulty determining your blood pressure.
- ┌ Should the device detect a condition that is abnormal, it will stop the measurement and display an error symbol. See page 4 for the description of symbols.
- ┌ This blood pressure monitor is intended for use by adults only. Consult with your physician before using this device on a child. A child should not use this device unattended.

Recalling Memory Data

Note: This device stores the last sixty measurements in memory automatically. The data is retained as long as the batteries are in the device. When you remove the batteries or the batteries are drained, the data will be erased.

1. Press the MEMORY button.
2. The date and the most recent data are displayed.
3. When the MEMORY button is pressed while data is displayed, the previous data is displayed.
4. After the last data is displayed, the display goes blank.
5. Press and hold the MEMORY button until the “**M**” (memory) mark blinks to clear the stored data.

Press the MEMORY button

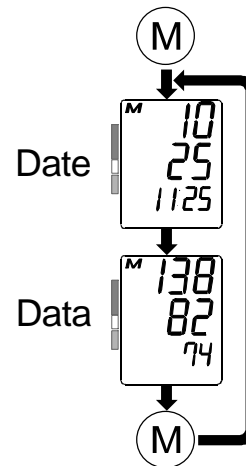

Note: Pressing the **START** button while the memory data is displayed initiates the UA-787*Plus* to start taking a measurement.

What Is An Irregular Heartbeat

Model UA-787*Plus* blood pressure monitor provides a blood pressure and pulse rate measurement even when an irregular heartbeat occurs. An irregular heartbeat is defined as a heartbeat that varies by 25% from the average of all heartbeats during the blood pressure measurement. It is important that you be relaxed, remain still and do not talk during measurements.

Note: We recommend contacting your physician if you see this «♥» indicator frequently.

Pressure Bar Indicator

The indicator monitors the progress of pressure during measurement.

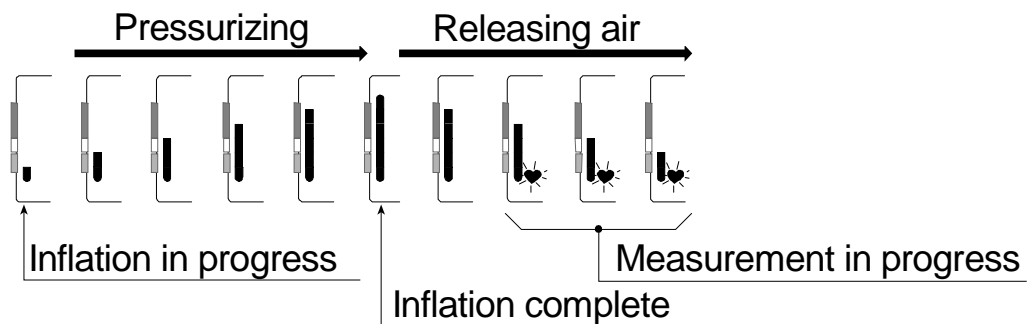

WHO Classification Indicator

Each segment of the bar indicator corresponds to the WHO blood pressure classification described on the next page.

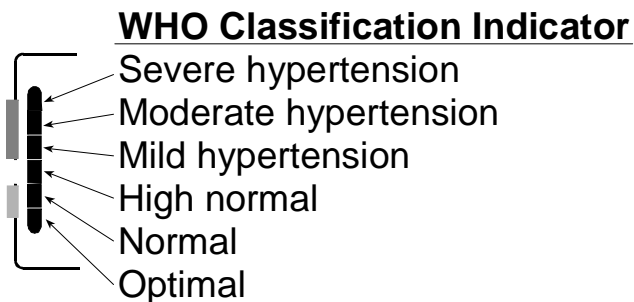

■ : The indicator displays a segment, based on the current data, corresponding to the WHO classification.

Example:

Moderate hypertension
 174
 102
 87

Mild hypertension
 147
 98
 87

High normal
 134
 87
 87

About Blood Pressure

What Is Blood Pressure?

Blood pressure is the force exerted by blood against the walls of the arteries. Systolic pressure occurs when the heart contracts. Diastolic pressure occurs when the heart expands. Blood pressure is measured in millimeters of mercury (mmHg). One's natural blood pressure is represented by the fundamental pressure, which is measured first thing in the morning while one is still at rest and before eating.

What Is Hypertension And How Is It Controlled?

Hypertension, an abnormally high arterial blood pressure, if left unattended, can cause many health problems including stroke and heart attack. Hypertension can be controlled by altering lifestyle, avoiding stress, and with medication under a doctor's supervision.

To prevent hypertension or keep it under control:

- └ Do not smoke
- └ Reduce salt and fat intake
- └ Maintain proper weight
- └ Exercise regularly
- └ Have regular physical checkups

Why Measure Blood Pressure At Home?

Blood pressure measured at a clinic or doctor's office may cause apprehension and can produce an elevated reading, 25 to 30 mmHg higher than that measured at home. Home measurement reduces the effects of outside influences on blood pressure readings, supplements the doctor's readings and provides a more accurate, complete blood pressure history.

WHO Blood Pressure Classification

Standards to assess high blood pressure, without regard to age, have been established by the World Health Organization (WHO), as shown in the chart.

Reference Material: Journal of Hypertension 1999, Vol 17 No.2

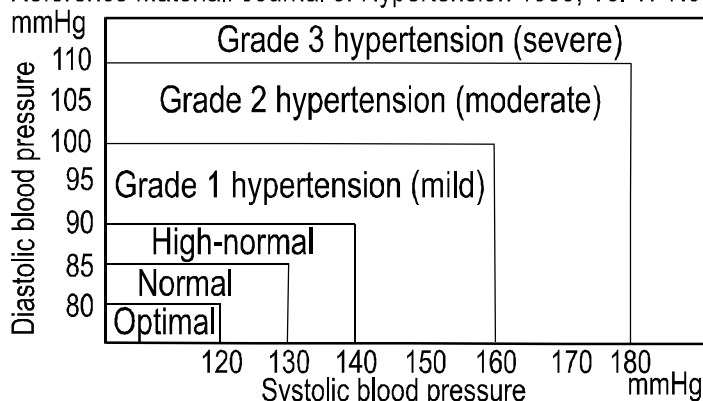

Blood Pressure Variations

An individual's blood pressure varies greatly on a daily and seasonal basis. It may vary by 30 to 50 mmHg due to various conditions during the day. In hypertensive individuals, variations are even more pronounced. Normally, the blood pressure rises while at work or play and falls to its lowest levels during sleep. So, do not be overly concerned by the results of one measurement.

Take measurements at the same time every day using the procedure

described in this manual to get to know your normal blood pressure. Regular readings give a more comprehensive blood pressure history. Be sure to note date and time when recording your blood pressure. Consult your doctor to interpret your blood pressure data.

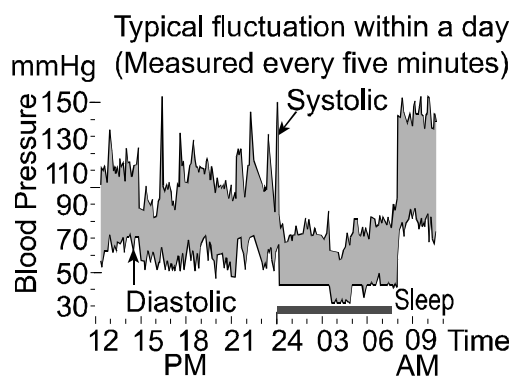

Troubleshooting

Problem	Possible Reason	Recommended Action
Nothing appears in the display, even when the power is turned on.	Batteries are drained.	Replace all batteries with new ones.
	Battery terminals are not in the correct position.	Reinstall the batteries with negative and positive terminals matching those indicated on the battery compartment.
The cuff does not inflate.	Battery voltage is too low.  (LOW BATTERY mark) blinks. [If the batteries are drained completely, the mark does not appear.]	Replace all batteries with new ones.
The unit does not measure. Readings are too high or too low.	The cuff is not fastened properly.	Fasten the cuff correctly.
	You moved your arm or body during the measurement.	Make sure you remain very still and quiet during the measurement.
	The cuff position is not correct.	Sit comfortably and still. Raise your hand so that the cuff is at the same level as your heart.
	_____	If you have a very weak or irregular heart beat, the device may have difficulty in determining your blood pressure.
Other	The value is different from that measured at a clinic or doctor's office.	See "Why measure blood pressure at home".
	_____	Remove the batteries. Place them back properly and try the measurement again.



Note: If the actions described above do not solve the problem, contact the dealer. Do not attempt to open or repair this product, as any attempt to do so will make your warranty invalid.

Maintenance

Do not open the device. It uses delicate electrical components and an intricate air unit that could be damaged. If you cannot fix the problem using the troubleshooting instructions, request service from your dealer or from the A&D service group. The A&D service group will provide technical information, spare parts and units to authorized dealers.

The device was designed and manufactured for a long service life. However it is generally recommended to have the monitor inspected every 2 years, to ensure proper functioning and accuracy. Please contact either your authorized dealer or A&D for maintenance.

Technical Data

Type	UA-787 <i>Plus</i>
Measurement method	Oscillometric measurement
Measurement range	Pressure: 20 - 280 mmHg Pulse: 40 - 200 beats / minute
Measurement accuracy	Pressure: ± 3 mmHg or 2%, whichever is greater Pulse: $\pm 5\%$
Power supply	4 x 1.5V batteries (R6P, LR6 or AA)
Upper arm circumference	17 - 32 cm
Classification	Type BF 
Clinical test	According to ANSI / AAMI SP-10 1987
EMC	IEC 60601-1-2: 2001
Memory	Last 60 measurements
Operating condition	+10°C to +40°C / 30%RH to 85 %RH
Storage condition	-10°C to +60°C / 30%RH to 85 %RH
Dimensions	Approx. 163 [W] x 62 [H] x 112 [D] mm
Weight	Approx. 350 g, excepting batteries
	 0366

Note: Specifications are subject to change without prior notice.

