

Bedside Scale

INSTRUCTION MANUAL

AD-6121A

For Sales & Service Contact UK Distributor
P.M.S (Instruments) Ltd
Waldeck House
Waldeck Road
Maidenhead
SL6 8BR
Tel 01628 773233
Fax 01628 770562



A&D

A&D Company, Limited

1WMPD4001194B

This Manual and Marks

All safety messages are identified by the following, “WARNING” or “CAUTION”, of ANSI Z535.4 (American National Standard Institute: Product Safety Signs and Labels). The meanings are as follows:

 WARNING	A potentially hazardous situation which, if not avoided, could result in death or serious injury.
 CAUTION	A potentially hazardous situation which, if not avoided, may result in minor or moderate injury.



This is a hazard alert mark.

- This manual is subject to change without notice, at any time, to improve the product.
- The product specifications and the contents of this manual are subject to change without any obligation on the part of the manufacturer to update past products.
- Windows is a registered trademark of Microsoft Corporation.



CONTENTS

1. PRECAUTIONS	2
1.1. Safety Precautions	2
1.2. Handling Precautions	2
1.2.1. Installation	2
1.2.2. Precautions for use	2
2. COMPLIANCE WITH COUNCIL DIRECTIVES	3
3. FEATURES	3
4. PART NAMES AND ACCESSORIES	4
4.1. Display Symbols and Switches	5
5. BEFORE USE	6
5.1. Preparation Procedure	6
5.1.1. Using the AC adapter	6
5.1.2. Using the batteries	6
6. USING THE SCALE	7
6.1. Basic Weighing	7
6.2. Weighing with a Tare	8
7. CALIBRATION	9
7.1. About Calibration	9
7.2. Calibration Using a Calibration Weight	9
7.3. Adjusting the Gravitational Acceleration	12
8. DATA COMMUNICATION	13
8.1. RS-232C Serial Interface	13
8.1.1. Interface specifications	13
8.1.2. Data format	13
8.1.3. Output timing	13
8.2. Connecting to a Personal Computer	14
8.2.1. Connection procedure	14
8.2.2. Communication example	14
9. MAINTENANCE	15
9.1. Maintaining the Performance Quality	15
9.2. Cleaning the Scale	15
9.3. Storing the Scale	15
10. BEFORE ASKING FOR REPAIR	16
11. SPECIFICATIONS	17
11.1. Specifications	17
11.2. External Dimensions	17
11.3. Options	18
12. APPENDIX	19
12.1. The Value of Gravity at Various Locations	19
12.2. World Map	20



1. PRECAUTIONS



1.1. Safety Precautions

CAUTION

- Do not place the scale on a soft, wet or slippery floor. Place the scale on a solid and level floor.
- Do not place the scale in areas where it can be tripped over or kicked.
- Do not step on the scale if your feet are wet.
- Step on the center portion of the scale gently.
- Do not step on the display window.
- When carrying the scale, be sure to hold it by the handle, and do not swing around or bump the scale.
- Do not disassemble or modify the scale. Keep the scale free of moisture, dust and foreign materials.
- Only qualified personnel can repair the scale. Attempting repairs yourself may cause a fire or damage to the scale. Damage caused by attempting to do the repair yourself will void the warranty.



1.2. Handling Precautions

1.2.1. Installation

- Place the scale on a flat floor free from vibrations and drafts. The floor should be solid enough to support the weight of the scale and the person being weighed.
- Place the scale where it is not exposed to direct sunlight.
- Place the scale where it is not exposed to external noises and strong electromagnetic waves.
- Place the scale where there are no corrosive, flammable, or explosive substances.
- Keep the temperature and the humidity of the installation site within the specified operating temperature range/humidity.

1.2.2. Precautions for use

- The maximum weighing capacity of the scale is 150 kg. Do not place anything on the scale that is beyond the weighing capacity.
- Stand still on the scale during weighing operation.
- Keep the cables of the AC adapter and other options away from the scale top surface. If they are in contact to the scale surface, a weighing error may occur.
- Press the ON/OFF switch and the ZERO switch gently. Do not kick them.



2. COMPLIANCE WITH COUNCIL DIRECTIVES

CE This device conforms to the following Council Directives.

Council directive 89/336/EEC	EN61326	EMC directive
Council directive 73/23/EEC	EN61010-1	Low voltage directive



3. FEATURES

- AD-6121A is a verified compact, lightweight scale that can be carried.
- Three displaying modes are available:
 - Personal Holds the weight on the display for about 5 seconds after the person being weighed steps off the scale.
 - Screening Holds the weight on the display while the person being weighed is on the scale.
 - Scale Displays the weight without holding it. Suitable to the weighing with a tare.
- The displaying direction can be changed.

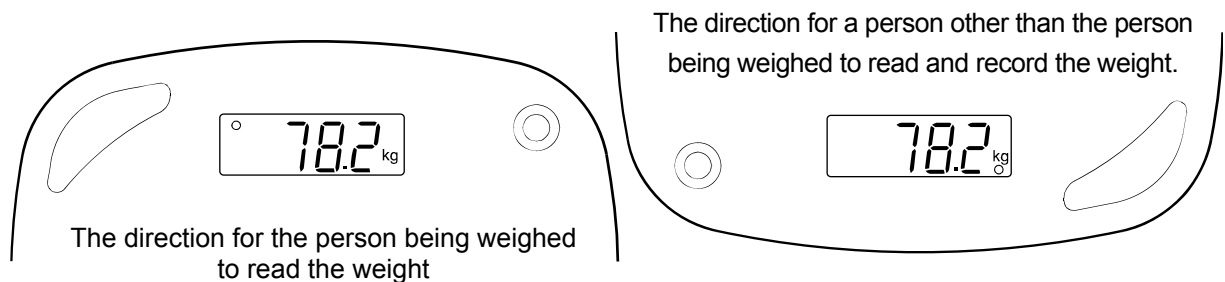

- The display is equipped with the backlight so that the weight can be read in dark areas. (Only when the AC adapter is used.)
- The buzzer indicates the weighing conditions. The buzzer can be switched off.
- Power is supplied by either batteries or the AC adapter.
- Automatic power shut-off function, when batteries are used, turns off the power automatically after two minutes of non-operation.



4. PART NAMES AND ACCESSORIES

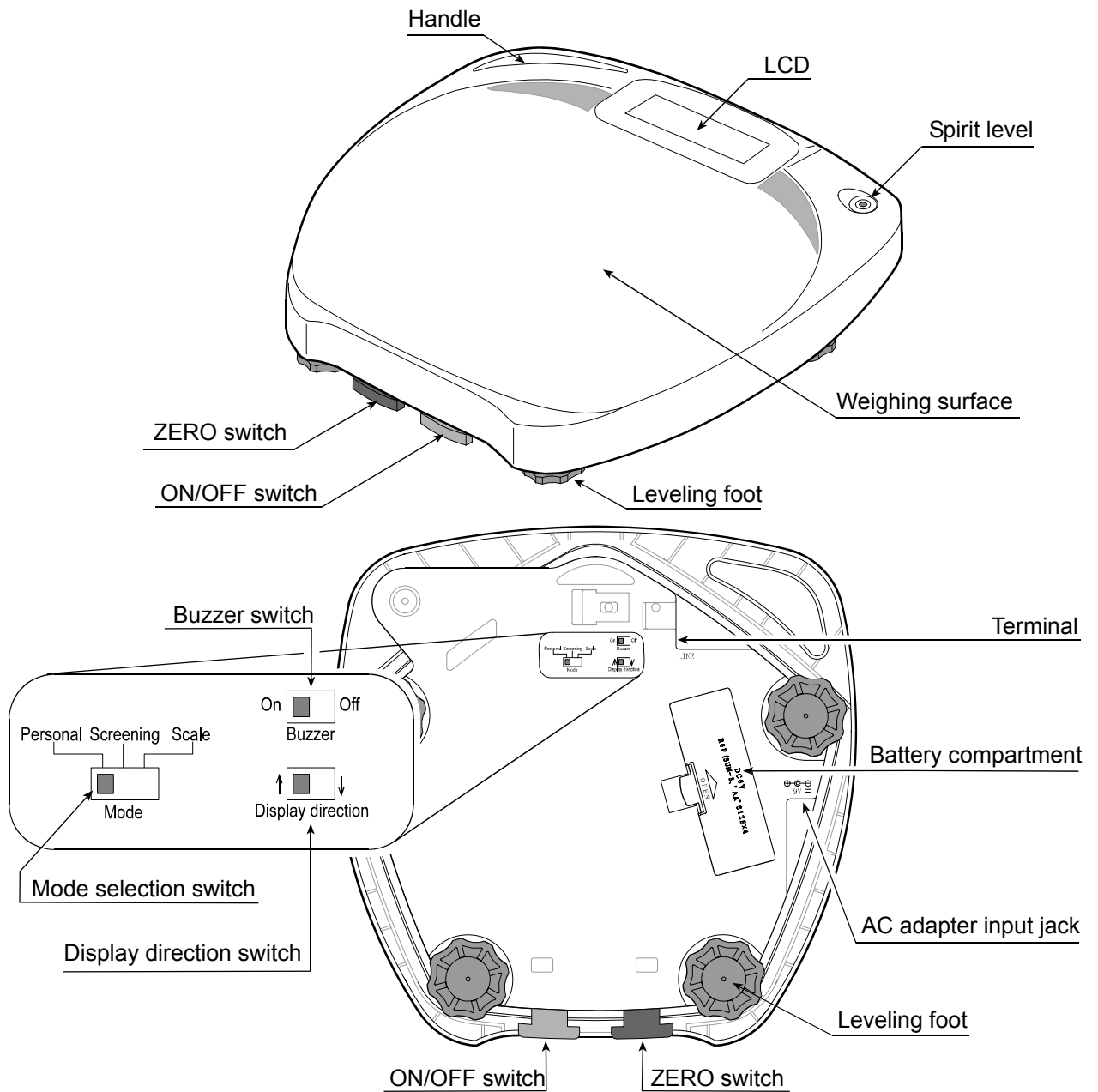

Accessories

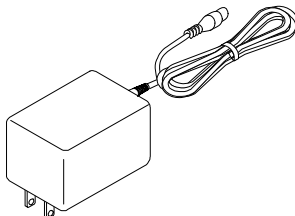

AC adapter



Instruction manual

Note

The shape of the adapter plug may differ from that of the illustration, depending on the country where the scale is used. Please confirm that the AC adapter type is correct for your local voltage and receptacle type.



4.1. Display Symbols and Switches

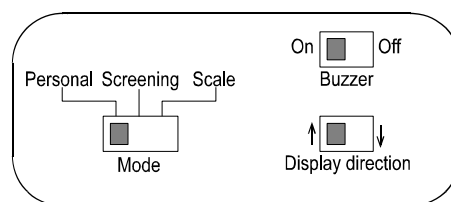
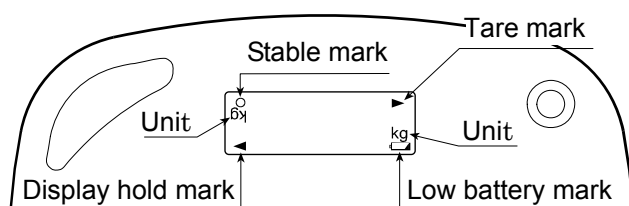

Switches

Display symbols

Symbols	Description
○ Stable mark	This symbol appears when the displayed weight is stable.
▶ Tare mark	This symbol appears when tare operation is in progress.
⎓ Low battery mark	This symbol appears when the batteries are drained. Replace the batteries with four new type AA batteries.
◀ Display hold mark	This symbol appears when the scale holds the weight on the display.

Switches

Switches	Description
① ON/OFF switch	Turns the scale on and off.
→0← ZERO switch	Sets the displayed weight to zero. When this switch is pressed after placing an object of 3 kg or more on the scale, the tare mark ▶ turns on.
Mode selection switch	Selects how the scale holds the displayed weight.
Personal	Holds the weight when it becomes stable and displays the value for about 5 seconds after the person being weighed steps off the scale. Used when the person being weighed reads the value. When changes of 3 kg or more occurs in the value, or 5 seconds after the person being weighed steps off the scale, the display hold is released.
Screening	Holds the weight when it becomes stable and displays the value as long as the person being weighed is on the scale. When the person steps off the scale, the display hold is released. Used when a person other than the person being weighed reads the value. When changes of 3 kg or more occurs in the value, the display hold is released.
Scale	Does not hold the value. Used for weighing an object other than body weight.
Display direction switch	Selects the display direction.
↑	Used when the person being weighed reads the weight.
↓	Used when a person other than the person being weighed reads the weight.
Buzzer switch	Selects whether to sound the buzzer or not.
On	Sounds the buzzer when the scale is turned on or the scale holds the weight.
Off	Does not sound the buzzer.

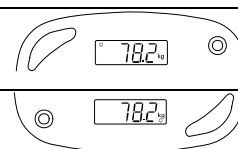

Note

The settings of the Mode selection switch, Display direction switch and Buzzer switch become effective after the ON/OFF switch is turned off and then turned on again.



5. BEFORE USE



5.1. Preparation Procedure

- 1 Use the accessory AC adapter or four type AA alkaline batteries.
- 2 Place the scale on a solid floor and level the scale using the leveling feet so that the bubble in the spirit level is centered.

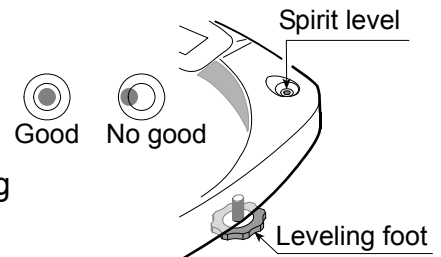

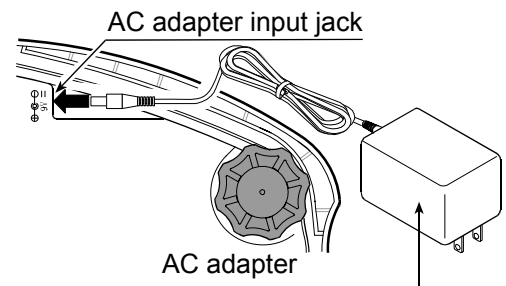

5.1.1. Using the AC adapter

- 1 Insert the AC adapter plug into the AC adapter input jack, and the AC adapter into an electrical outlet.



5.1.2. Using the batteries

⚠ CAUTION

- When installing the batteries, match the + (positive) and – (negative) terminals to those indicated in the battery compartment.
 - Use four type AA batteries.
 - Do not mix old and new batteries.
 - Remove the batteries if the scale is not to be used for a long period of time. The batteries may leak and cause a malfunction.
 - If the battery liquid spills on the body, wash the body part under running water immediately.
- When the Low battery mark  appears, replace the batteries with four new type AA batteries. Please note that the Low battery mark  does not appear when the batteries are completely drained.
 - Even when the batteries are installed, connecting the AC adapter will make the AC adapter effective.
 - When the batteries are used, the backlight does not turn on.

- 1 Remove the battery compartment cover.
- 2 Install four new type AA batteries into the battery compartment, taking care that the polarities (+) and (-) are correct.
- 3 Replace the battery compartment cover.

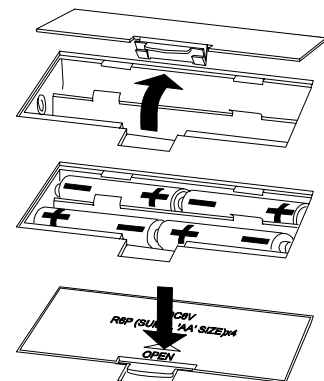



6. USING THE SCALE



6.1. Basic Weighing

- 1 Make sure that nothing is placed on the scale.
- 2 Press the ON/OFF switch to turn the scale on.
All the display segments turn on and then the zero display appears.
When the AC adapter is used, the display backlight turns on.
- 3 Press the ZERO switch.
If the displayed value is not zero, press the ZERO switch.
- 4 Step on the scale gently and read the weight.
The scale displays the weight. When the value is stable, the Stable mark  turns on.
- 5 Step off the scale gently.
- 6 To weigh again, repeat steps 3 to 5.
- 7 Press the ON/OFF switch to turn the scale off.

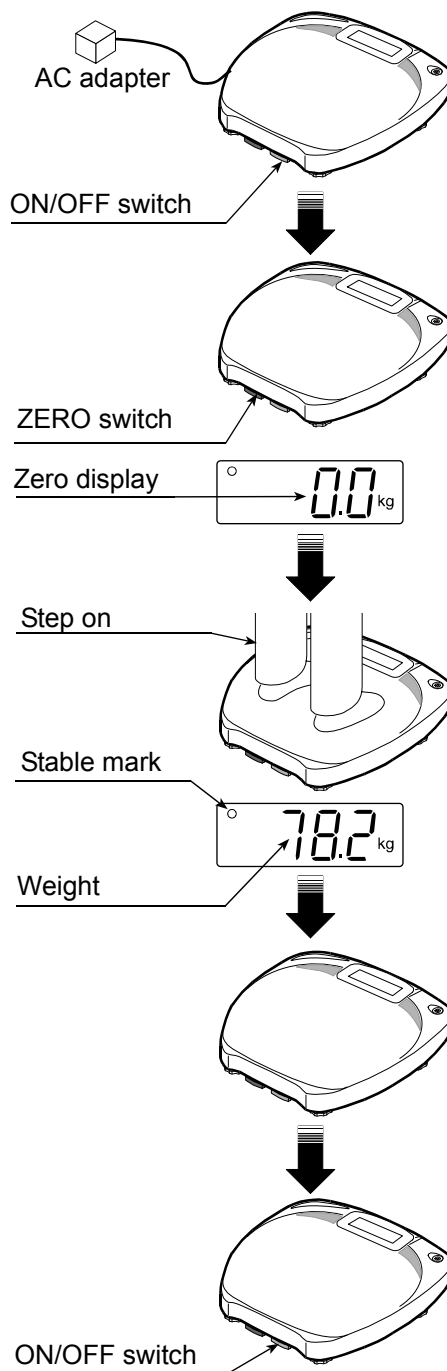



6.2. Weighing with a Tare

- In weighing with a tare, the scale stores the tare weight, turns on the tare mark ► and displays the net weight. The tare range is 3 kg to 150 kg.

Net weight = Gross weight – Tare weight (Example of tare items: Clothes, plate and container)

- For weighing an object other than body weight, the scale mode, that does not hold the weight, is convenient.

Procedure for weighing with a tare

- 1 Make sure that nothing is placed on the scale.

- 2 Press the ON/OFF switch to turn the scale on.

All the display segments turn on and then the zero display appears. If the displayed value is not zero, press the ZERO switch.

- 3 Place the tare on the scale gently.

Place a tare item of 3 kg or more on the scale. When the value is stable, the Stable mark ○ turns on.

- 4 Press the ZERO switch.

The tare mark ► turns on and the display is set to zero.

- 5 Place the object to be weighed on the scale and read the weight.

The scale displays the net weight. When the weight is stable, the Stable mark ○ turns on.

- 6 Remove the object weighed with a tare from the scale.

- 7 Press the ON/OFF switch to turn the scale off.

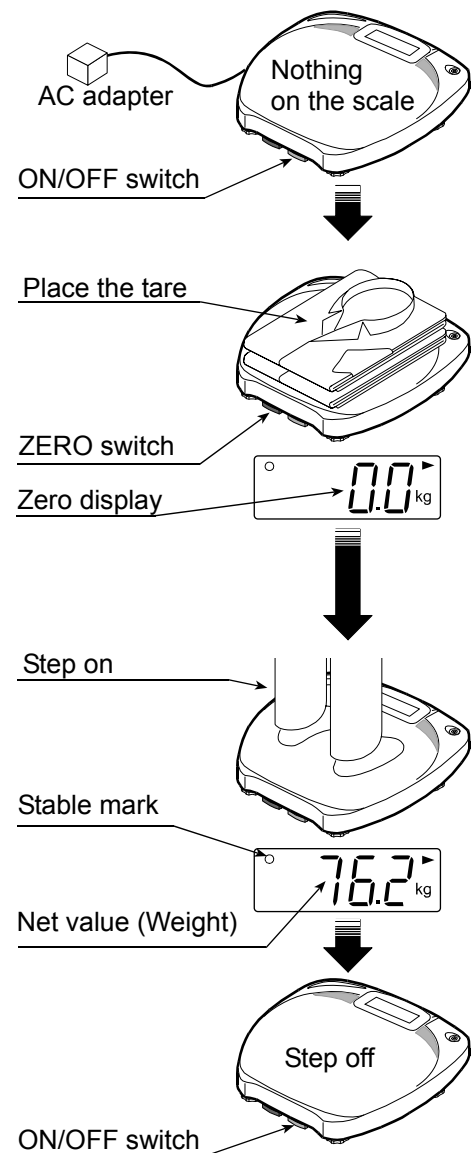

Releasing “Weighing with a tare” (Canceling the tare mark ►)

- With nothing on the scale, press the ZERO switch.
- Press the ON/OFF switch to turn off the scale and press the ON/OFF switch to turn on the scale again.



7. CALIBRATION



7.1. About Calibration

Calibration is the function to adjust the scale so that it can weigh accurately.

When the verification seal is broken, re- verification is required.

Break the verification seal and locate the CAL switch cover on the scale bottom. Slide the CAL switch cover in the direction indicated by the arrow.

The CAL switch is on the board inside.

- When pressing the CAL switch, do not use a sharp object such as a ballpoint pen. It may cause the scale to malfunction.

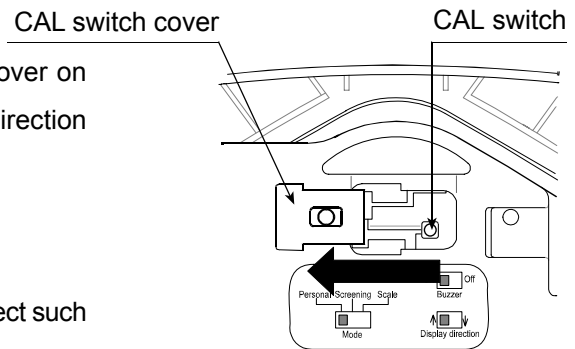

Bottom of the scale



7.2. Calibration Using a Calibration Weight

- 1 While holding down the CAL and ZERO switches, press and hold the ON/OFF switch for about 2 seconds.

All of the display segments turn on. Release the switches after about 2 seconds.

- 2 While all the display segments are on (about 5 seconds), press the CAL switch 3 times.

The display indicates [- - -].

If the CAL switch is not pressed 3 times within about 5 seconds after step 1, the power will be turned off automatically.

- 3 Press the ZERO switch.

The display indicates [C-0].

- 4 Press the ZERO switch several times until [C-5] is displayed.

Each time the ZERO switch is pressed, the number increases by 1; [C-0] [C-1] [C-2]

- 5 Press the ON/OFF switch.

The display indicates [20], which means the temperature for calibration is 20°C. Here, adjust the value as necessary.

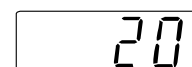
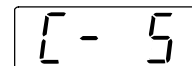
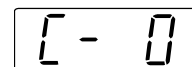
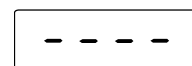

- 6 Press the ZERO switch to adjust the temperature setting.

When the Display direction switch is set to \uparrow , each time the ZERO switch is pressed, the number increases by 1.

When the Display direction switch is set to \downarrow , each time the ZERO switch is pressed, the number decreases by 1.

- 7 Press the ON/OFF switch.

The scale stores the new temperature setting for calibration and [C-6] is displayed.

- 8 Press the ON/OFF switch.

The display indicates [9798], which means the gravitational acceleration setting for the calibration site is 9.798 m/s^2 . Here, adjust the value as necessary.

- 9 Press the ZERO switch to adjust the gravitational acceleration.

When the Display direction switch is set to \uparrow , each time the ZERO switch is pressed, the number increases by 1.

When the Display direction switch is set to \downarrow , each time the ZERO switch is pressed, the number decreases by 1.

Note

The gravity values for various locations are listed on page 19.

- 10 Press the ON/OFF switch.

The scale stores the new gravitational acceleration value and [C-7] is displayed.

- 11 Press the ZERO switch several times until [C-10] is displayed.

Each time the ZERO switch is pressed, the number increases by 1; [C-8] [C-9] [C-10]

- 12 Press the ON/OFF switch.

The display indicates the AD count for the current output of the thermo-sensitive resistor. Wait for the Stable mark to turn on.

- 13 When the Stable mark is displayed, press the ON/OFF switch.

The scale stores the AD count for the current output of the thermo-sensitive resistor and moves to the next item [C-11].

When the ZERO switch is pressed in place of the ON/OFF switch, the scale moves to [C-11] without storing the AD count.

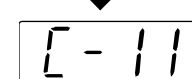
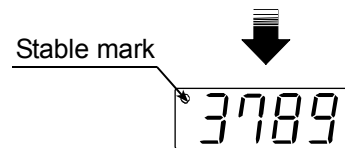
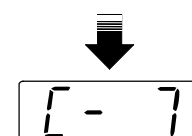
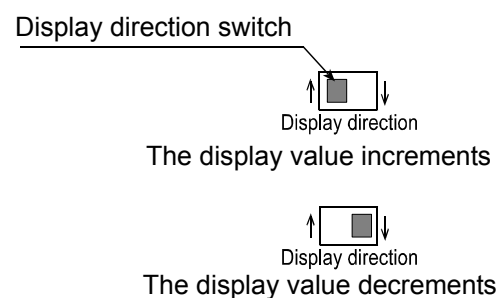
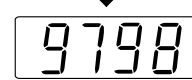
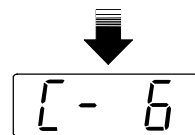
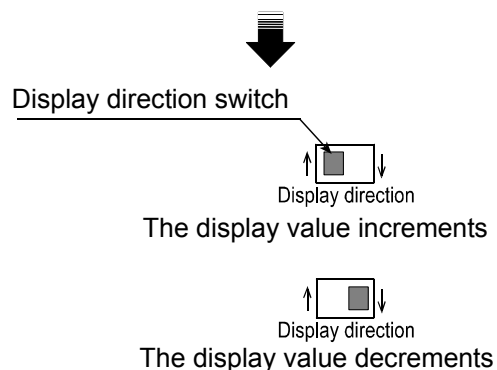

14 With [C-11] displayed, press the ON/OFF switch.

The display indicates [CAL0].

15 Make sure that nothing is placed on the scale and wait for the Stable mark to turn on.

16 Press the ON/OFF switch.

The scale stores the zero point data and moves to the next item [C-12].

When the ZERO switch is pressed in place of the ON/OFF switch, the scale moves to [C-12] without storing the zero point data.

17 With [C-12] displayed, press the ON/OFF switch.

The display indicates [CAL1].

18 Place a 150-kg (weighing capacity) weight on the scale and wait for the Stable mark to turn on.

19 Press the ON/OFF switch.

The scale stores the span data and moves to the next item [END].

When the ZERO switch is pressed in place of the ON/OFF switch, the scale moves to [END] without storing the span data.

20 After the scale indicates [END], the power is turned off automatically.

Remove the weight from the scale. Calibration has been completed.

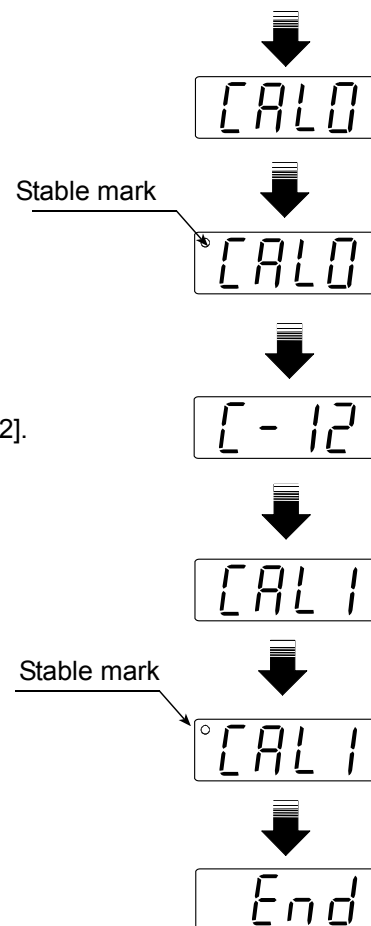

Note

A room with a temperature of around 25 °C with little temperature change is needed. Perform calibration only after the temperature of a scale and the temperature of the room are the same. Place the scale on a level surface, and after pre-load do not move the scale until calibration is over.



7.3. Adjusting the Gravitational Acceleration

Adjust the gravitational acceleration to that of the installation site.

When the scale is transported to a different area, the adjustment is required.

Note

The gravity values for various locations are listed on page 19.

1 Set the Mode selection switch to [Personal].

2 While holding down the CAL switch, press and hold the ON/OFF switch for about 2 seconds.

All of the display segments turn on. Release the switches after about 2 seconds.

3 While all the display segments are on (about 5 seconds), press the CAL switch 3 times.

The display indicates [9798], which means the gravitational acceleration setting for the installation site is 9.798 m/s².

If the CAL switch is not pressed 3 times within about 5 seconds after step 2, the power will be turned off automatically.

4 Press the ZERO switch to adjust the gravitational acceleration.

When the Display direction switch is set to ↑, each time the ZERO switch is pressed, the number increases by 1.

When the Display direction switch is set to ↓, each time the ZERO switch is pressed, the number decreases by 1.

5 Press the ON/OFF switch.

The scale stores the new gravitational acceleration value and the power is turned off automatically.

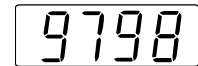
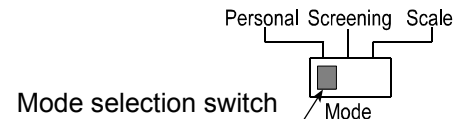

Display direction switch

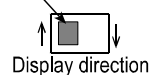

The display value increments

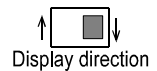

The display value decrements



8. DATA COMMUNICATION



8.1. RS-232C Serial Interface

- The AD-6121A scale has an RS-232C serial interface installed as standard.
- Using the optional RS-232C cable (AX-KO2238), the scale can send the data to external devices such as a personal computer.

8.1.1. Interface specifications

Transmission system	: EIA RS-232C
Transmission form	: Asynchronous, half duplex
Baud rate	: 2400 bps
Data bits	: 7 bits
Parity	: 1 bit, Even, Odd
Stop bit	: 1 bit
Code	: ASCII
Terminator	: CR LF (CR: 0Dh, LF: 0Ah)

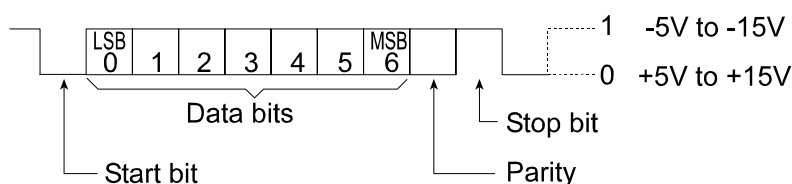

8.1.2. Data format

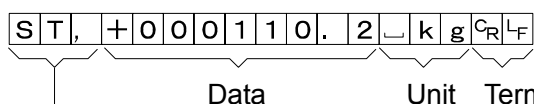

- S T** Stable header: Added when the Stable mark \bigcirc is turned on.
- U S** Unstable header: Added when the weight value is not stable.
- O L** Overload header: Added when the weight value is beyond the weighing capacity. When overloading, [E] or [-E] appears on the display.

- \square Space (20h)
- \square Carriage return (CR: 0Dh)
- \square Line feed (LF: 0Ah)

8.1.3. Output timing

Mode selection switch	Output timing
Personal, Screening	Outputs the weight value once when the scale holds it on the display.
Scale	Outputs the weight value 4 or 5 times per second after zero display.



8.2. Connecting to a Personal Computer

8.2.1. Connection procedure

The below is an example of connecting the scale to a Windows-based personal computer.

- 1 Insert the optional RS-232C cable (AX-KO2238) into the LINE (External output terminal) jack located on the bottom of the scale.

- 2 Insert the D-Sub 9-pin connector of the RS-232C cable into the RS-232C port (COM1 port) located on the personal computer.

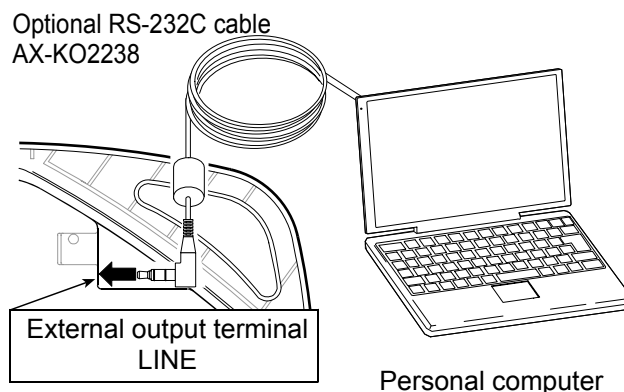

8.2.2. Communication example

The below is an example of communication with a Windows-based personal computer.

- 1 Make a connection between the scale and the personal computer as described above.
- 2 Select [Start], [Program], [Accessories] and [Hyper Terminal].
If Hyper Terminal is not installed, install it using [Add Remove Programs].
- 3 Double-click the Hyper Terminal icon to start Hyper Terminal.
Click [Cancel] when a guide to the modem installation appears.
- 4 A new window opens. Give it a proper name and click [OK].
- 5 The settings window appears. Select [Direct to COM1] for connection method and click [OK].
- 6 Set the port on the COM1 properties window and click [OK].

Baud rate	: 2400 bps
Data bits	: 7 bits
Parity	: 1 bit, Even, Odd
Stop bit	: 1 bit
Flow control	: Hardware
- 7 Press the ON/OFF switch to turn the scale on.
- 8 The data is output as described in “8.1.3 Output timing” and displayed on the personal computer.



9. MAINTENANCE



9.1. Maintaining the Performance Quality

- Check the scale regularly to make sure that it weighs correctly, and perform inspection or calibration as necessary. For details on inspection or calibration, contact the local A&D dealer.



9.2. Cleaning the Scale

- To clean the scale, use a soft cloth that is moistened with water and a mild detergent solution. After moistening, the cloth must be squeezed or rung out, so that it is not dripping wet.
- Do not use organic solvents such as thinner, benzine or methanol to clean the scale.
- Do not use a disinfectant that contains chlorine to clean the scale.
- Do not expose the scale to strong ultraviolet radiation or high temperature water vapor.



9.3. Storing the Scale

- When storing the scale:
 - Make sure that nothing is placed on the scale.
 - Make sure that the ON/OFF switch is not left pressed.
 - Remove the batteries.
- Do not store the scale:
 - Where it is exposed to high temperature or high humidity.
 - Where salinity, sulfur content or corrosive gases exist.
 - Where chemicals are stored.



10. BEFORE ASKING FOR REPAIR

□ Before asking for repair, refer to the table below.

When	What to do
Nothing appears on the display, even when the scale is turned on.	Check whether the AC adapter or batteries are installed correctly. Check whether the batteries are drained.
[----] remains on the display and does not change.	Check that nothing is placed on the scale. Check that nothing is touching the scale.
The difference between an estimated weight and the actual weight is large.	Check that the scale is leveled. Check that nothing is touching the scale.
The switches do not function. The display does not change even when the switches are pressed.	Disconnect the AC adapter and connect it again. Then, turn the power on. Remove the batteries and insert them again. Then, turn the power on.
[E-1] , [E-2] or [E-4] appears on the display.	Ask for repair.
The buzzer remains sounding.	Check whether the ON/OFF switch is left pressed.
[E] appears.	This error appears when the object on the scale is beyond the weighing capacity. Remove the object from the scale.
[-E] appears	This error appears when the weight value is less than 3 kg. Check that nothing is placed on the scale and nothing is touching the scale. Then, turn the scale off and turn it on again.



11. SPECIFICATIONS



11.1. Specifications

Type	AD-6121A
Maximum weighing capacity	150 kg
Minimum display	100 g
Minimum weighing capacity	2 kg
Maximum tare	Maximum weighing capacity
Display	LCD with backlight (Backlight: Only when the AC adapter is used.) Displaying direction can be changed.
Operating temperature range/humidity	+5°C to +35°C, 85%RH or less, No condensation
Power supply	AC adapter or four type AA batteries (Not included)
Battery life	Approx. 1000 weighing operations (Varies depending on the type and ambient temperature.)
Buzzer	Buzzer switch to turn the buzzer on and off
External dimensions	314 (D) x 315 (W) x 57 (H) mm
Weight	Approx. 3.0 kg



11.2. External Dimensions

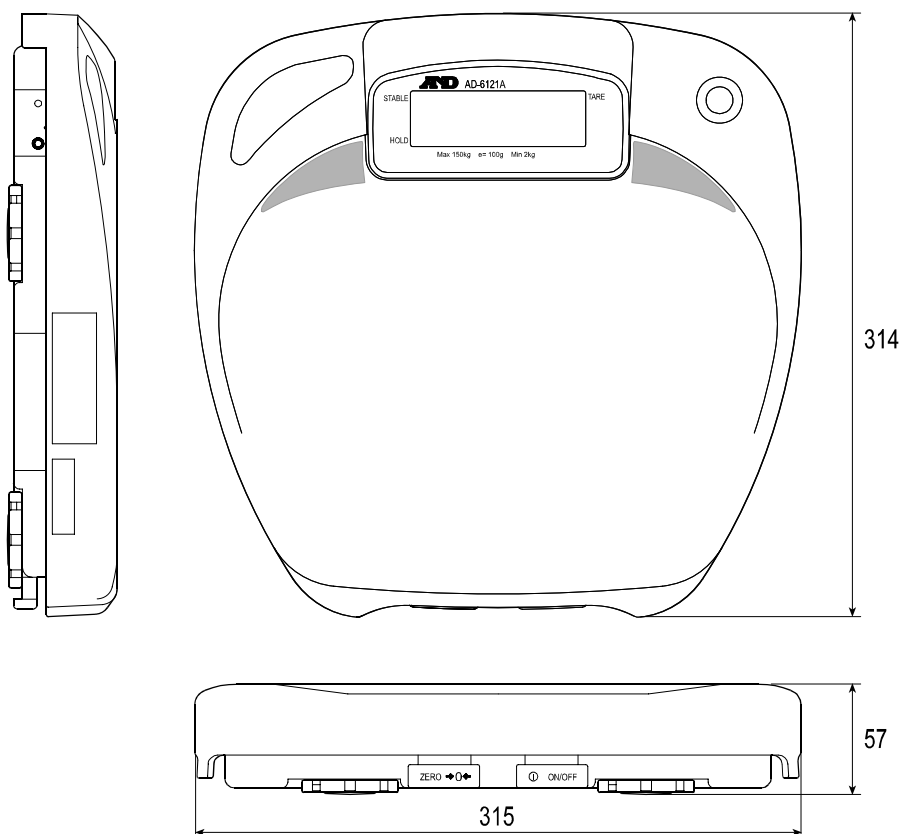

Unit: mm



11.3. Options

RS-232C cable	AX-KO2238
Use	RS-232C cable
	D-Sub 9-pin
Length	2 m

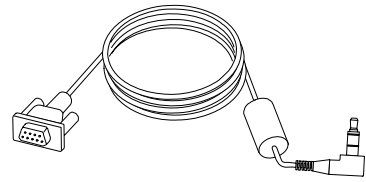



12. APPENDIX



12.1. The Value of Gravity at Various Locations

Amsterdam	9.813 m/s ²	Havana	9.788 m/s ²	Paris	9.809 m/s ²
Athens	9.807 m/s ²	Helsinki	9.819 m/s ²	Rio de Janeiro	9.788 m/s ²
Auckland, NZ	9.799 m/s ²	Kuwait	9.793 m/s ²	Rome	9.803 m/s ²
Bangkok	9.783 m/s ²	Lisbon	9.801 m/s ²	San Francisco	9.800 m/s ²
Birmingham	9.813 m/s ²	London (Greenwich)	9.812 m/s ²	Singapore	9.781 m/s ²
Brussels	9.811 m/s ²	Los Angeles	9.796 m/s ²	Stockholm	9.818 m/s ²
Buenos Aires	9.797 m/s ²	Madrid	9.800 m/s ²	Sydney	9.797 m/s ²
Calcutta	9.788 m/s ²	Manila	9.784 m/s ²	Taichung	9.789 m/s ²
Cape Town	9.796 m/s ²	Melbourne	9.800 m/s ²	Tainan	9.788 m/s ²
Chicago	9.803 m/s ²	Mexico City	9.779 m/s ²	Taipei	9.790 m/s ²
Copenhagen	9.815 m/s ²	Milan	9.806 m/s ²	Tokyo	9.798 m/s ²
Cyprus	9.797 m/s ²	New Delhi	9.791 m/s ²	Vancouver, BC	9.809 m/s ²
Djakarta	9.781 m/s ²	New York	9.802 m/s ²	Washington, DC	9.801 m/s ²
Frankfurt	9.810 m/s ²	Oslo	9.819 m/s ²	Wellington, NZ	9.803 m/s ²
Glasgow	9.816 m/s ²	Ottawa	9.806 m/s ²	Zurich	9.807 m/s ²

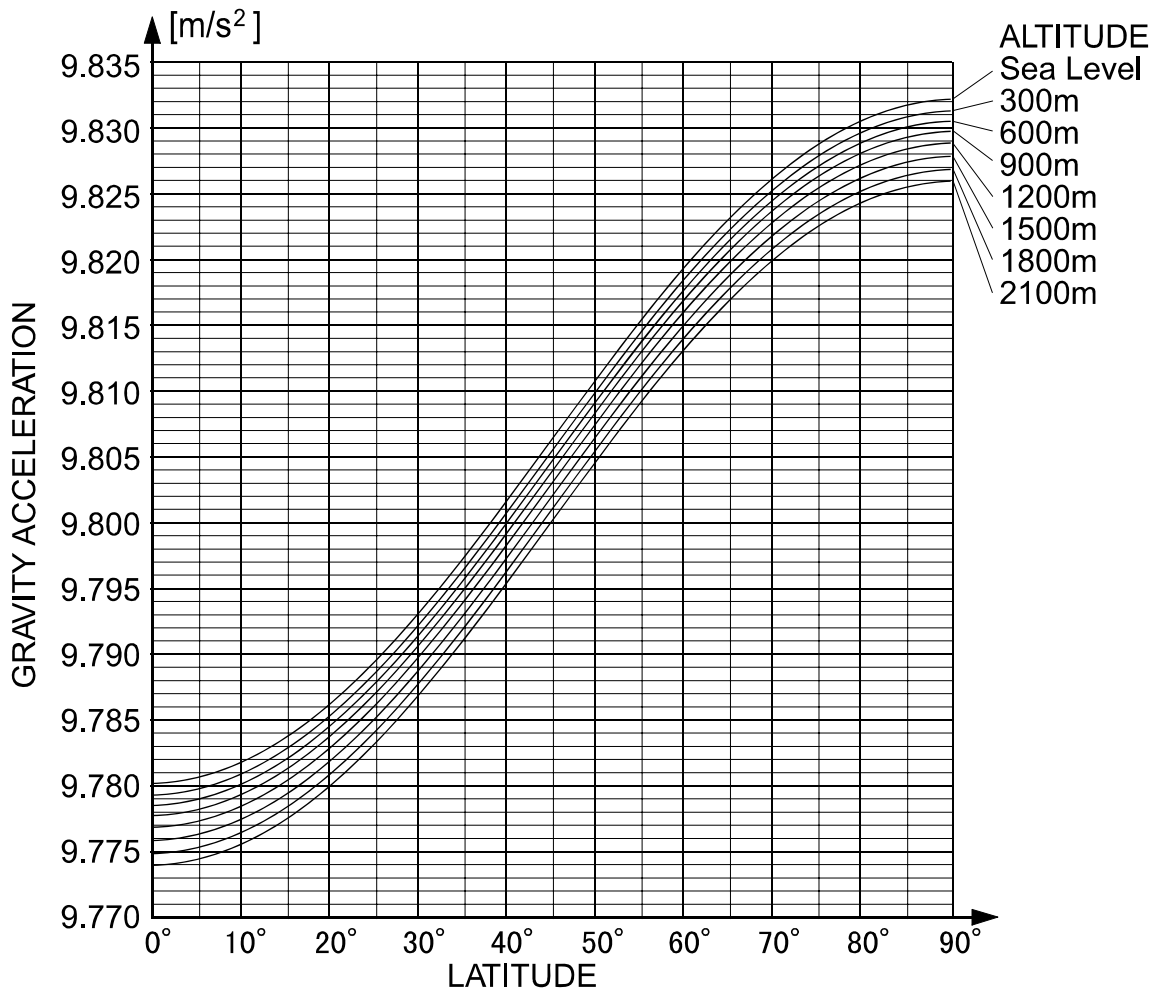



12.2. World Map

