

AND

Digital Blood Pressure Monitor

Model UA-767S

Instruction Manual

Original

ENGLISH

Manuel d'instructions

Traduction

FRANÇAIS

Manual de Instrucciones

Traducción

ESPAÑOL

Manuale di Istruzioni

Traduzione

ITALIANO

使用手冊

翻譯

中文

Contents

Dear Customers	2
Preliminary Remarks	2
Precautions	2
Parts Identification	4
Symbols	5
Operation Mode	7
Using the Monitor	8
Installing / Changing the Batteries	8
Connecting the Air Hose	9
Connecting the AC Adapter	9
Selecting the Correct Cuff Size	10
Applying the Arm Cuff	10
How to Take Accurate Measurements	12
Measurement	12
After Measurement	12
Measurements	13
Normal Measurement	13
Measurement with the Desired Systolic Pressure	14
Notes for Accurate Measurement	14
Recalling the Memory Data	15
What is an Irregular Heartbeat	16
%IHB	16
Pressure Bar Indicator	17
WHO Classification Indicator	17
About Blood Pressure	17
What is Blood Pressure?	17
What is Hypertension and How is it Controlled?	18
Why Measure Blood Pressure at Home?	18
WHO Blood Pressure Classification	18
Blood Pressure Variations	18
Troubleshooting	19
Maintenance	20
Technical Data	20

Dear Customers

Congratulations on purchasing a state-of-the-art A&D blood pressure monitor, one of the most advanced monitors available today. Designed for ease of use and accuracy, this monitor will facilitate your daily blood pressure regimen.

We recommend that you read through this manual carefully before using the device for the first time.

Preliminary Remarks

- This device conforms to the European Directive 93/42 EEC for Medical Products. This is made evident by the **CE**₀₁₂₃ mark of conformity. (0123: The reference number to the involved notified body)
- The device is designed for use on adults only, not newborns or infants.
- Environment for use. The device is for use in the home healthcare environment.
- This device is designed to measure blood pressure and pulse rate of people for diagnosis.

Precautions

- Precision components are used in the construction of this device. Extremes in temperature, humidity, direct sunlight, shock or dust should be avoided.
- Clean the device and cuff with a dry, soft cloth or a cloth dampened with water and a neutral detergent. Never use alcohol, benzene, thinner or other harsh chemicals to clean the device or cuff.
- Avoid tightly folding the cuff or storing the hose tightly twisted for long periods, as such treatment may shorten the life of the components.
- Take care to avoid accidental strangulation of babies or infants with the hose.
- Do not twist the air hose during measurement. This may cause injury due to continuous cuff pressure.
- The device and cuff are not water resistant. Prevent rain, sweat and water from soiling the device and cuff.
- Measurements may be distorted if the device is used close to televisions, microwave ovens, cellular telephones, X-ray or other devices with strong electrical fields.

- When reusing the device, confirm that the device is clean.
- Used equipment, parts and batteries are not treated as ordinary household waste, and must be disposed of according to the applicable local regulations.
- When the AC adapter is used, make sure that the AC adapter can be readily removed from the electrical outlet when necessary.
- Do not modify the device. It may cause accidents or damage to the device.
- To measure blood pressure, the arm must be squeezed by the cuff hard enough to temporarily stop blood flow through the artery. This may cause pain, numbness or a temporary red mark to the arm. This condition will appear especially when measurement is repeated successively. Any pain, numbness, or red marks will disappear with time.
- Measuring blood pressure too frequently may cause harm due to blood flow interference. Check that the operation of the device does not result in prolonged impairment of blood circulation, when using the device repeatedly.
- If you have had a mastectomy, please consult a doctor before using the device.
- Do not let children use the device by themselves and do not use the device in a place within the reach of infants.
- There are small parts that may cause a choking hazard if swallowed by mistake by infants.

Contraindications

The following are precautions for proper use of the device.

- Do not apply the cuff on an arm with another medical electrical equipment attached. The equipment may not function properly.
- People who have a severe circulatory deficit in the arm must consult a doctor before using the device, to avoid medical problems.
- Do not self-diagnose the measurement results and start treatment by yourself. Always consult your doctor for evaluation of the results and treatment.
- Do not apply the cuff on an arm with an unhealed wound.
- Do not apply the cuff on an arm receiving an intravenous drip or blood transfusion. It may cause injury or accidents.
- Do not use the device where flammable gases such as anesthetic gases are present. It may cause an explosion.
- Do not use the device in highly concentrated oxygen environments, such as a high-pressure oxygen chamber or an oxygen tent. It may cause a fire or explosion.

Parts Identification

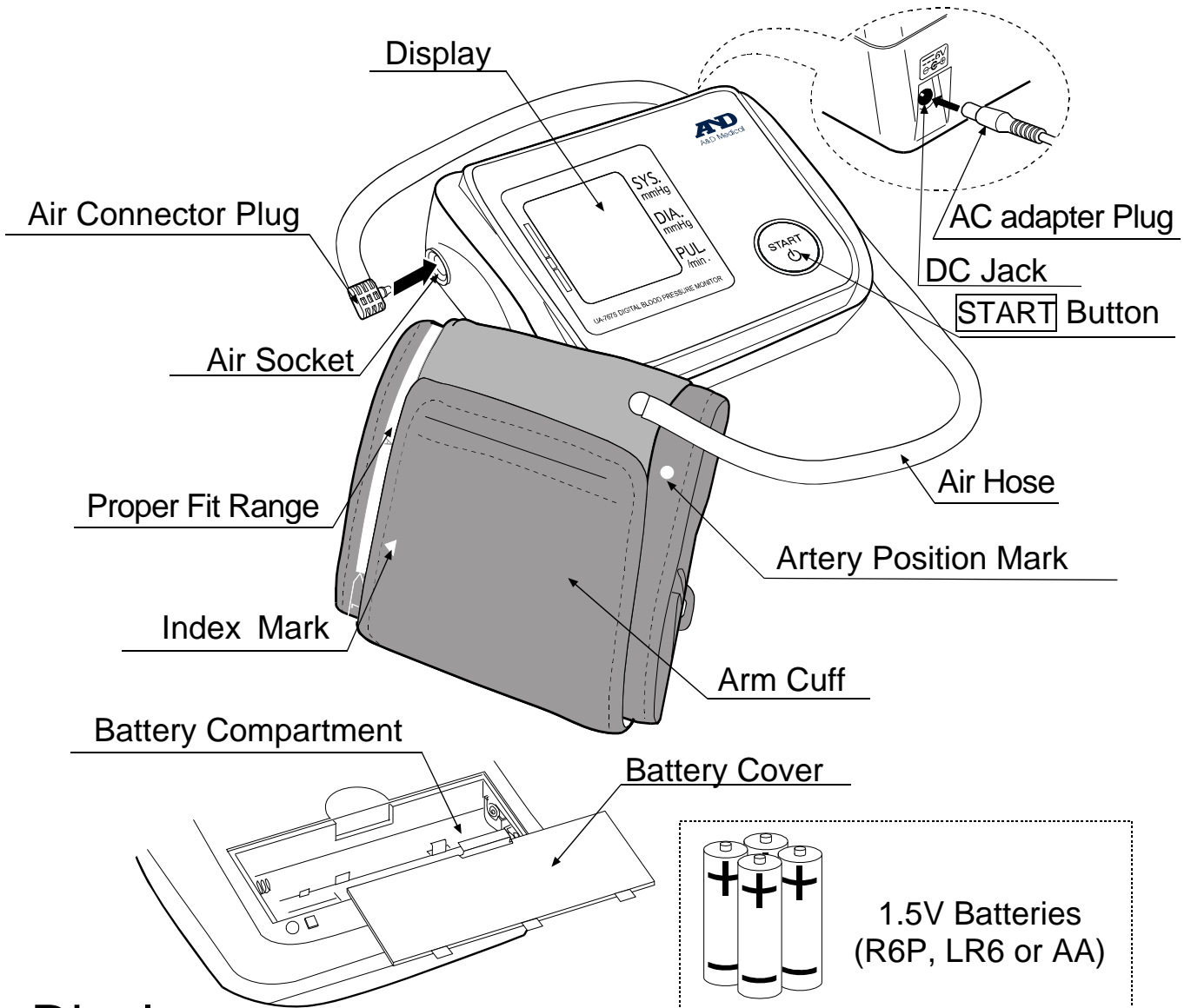



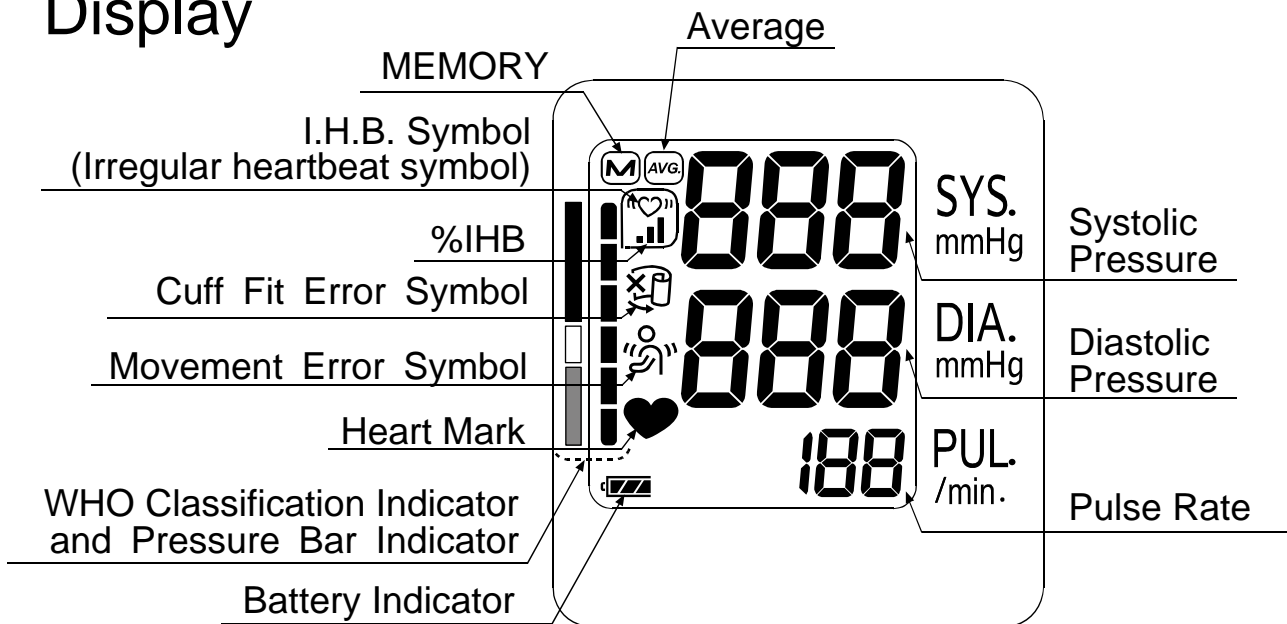





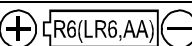

Display





Symbols









Symbols that are printed on the device case

Symbols	Function / Meaning
	Standby and Turn the device on.
SYS.	Systolic blood pressure in mmHg
DIA.	Diastolic blood pressure in mmHg
PUL.	Pulse per minute
	Battery installation guide
	Direct current
	Type BF: Device, cuff and tubing are designed to provide special protection against electrical shocks.
	EC directive medical device label
	EU-representative
	Manufacturer
2014 	Date of manufacture
IP	International protection symbol
	Class II device
	WEEE label
SN	Serial number
	Refer to instruction manual/booklet
	Polarity of DC jack

Symbols that appear on the display

Symbols	Function / Meaning	Recommended Action
	Appears while measurement is in progress. It blinks when the pulse is detected.	Measurement is in progress. Remain as still as possible.
	Irregular Heartbeat symbol (I.H.B.) Appears when an irregular heartbeat is detected. It may light when a very slight vibration like shivering or shaking is detected.	_____
	Appears when a body or arm movement is detected.	The reading may yield an incorrect value. Take another measurement. Remain still during measurement.

Symbols

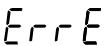
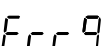
Symbols	Function / Meaning	Recommended Action
	Appears during measurement when the cuff is attached loosely	The reading may yield an incorrect value. Apply the cuff correctly, and take another measurement.
	Detected rate of IHB in memory $\%IHB = \frac{\left[\begin{array}{c} \text{Number of detected} \\ \text{IHBs in memory} \end{array} \right]}{\left[\begin{array}{c} \text{Total number} \end{array} \right]} \times 100 [\%]$	_____
	Previous measurements stored in memory.	_____
	Average data	_____
 Full Battery	The battery power indicator during measurement.	_____
 Low Battery	The battery is low when it blinks.	Replace all batteries with new ones when the mark blinks.
	Unstable blood pressure due to movement during measurement.	Take another measurement. Remain very still during measurement.
	The systolic and diastolic values are within 10 mmHg of each other.	Apply the cuff correctly, and take another measurement.
	The pressure value did not increase during the inflation.	
	The cuff is not applied correctly.	Apply the cuff correctly, and take another measurement.
 PUL. DISPLAY ERROR	The pulse is not detected correctly.	
	Blood pressure monitor internal error	Remove the batteries and press the START button, and then install the batteries again. If the error still appears, contact the dealer.
		

Operation Mode

1. Normal Measurement

Press the **START** button. Blood pressure is measured and the data is stored in memory. This device can store the last 60 measurements in memory.

2. Recalling the Data

When nothing is displayed, press and hold the **START** button.

Release the button when displaying the average data.

The data number and stored data are automatically displayed in order from the last measurement.

For details on recalling the data, Refer to "Recalling the Memory Data".

In standby,
press and hold the



button

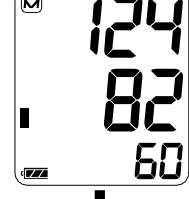
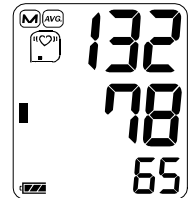

3. Deleting all Data Stored in Memory

When turning off the device, press and hold the **START** button until the "CLR no." is displayed.

Select "CLR YES" to clear data.

Data is cleared when the **M** mark blinks.

The device turns off automatically.

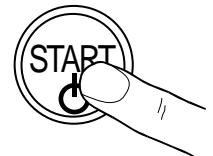

4. Measurement with the Desired Systolic Pressure

Refer to page 14 for measurement with the desired systolic pressure.



Using the Monitor

Installing / Changing the Batteries

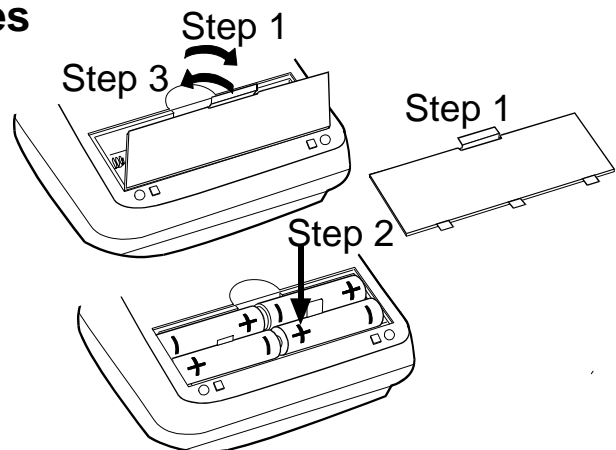
1. Remove the battery cover.
2. Remove the used batteries and insert new batteries into the battery compartment as shown, taking care that the polarities (+ and -) are correct.
Use only R6P, LR6 or AA batteries.
3. Attach the battery cover.



CAUTION

- Insert the batteries as shown in the battery compartment. If installed incorrectly, the device will not work.
- When  (LOW BATTERY mark) blinks on the display, replace all batteries with new ones. Do not mix old and new batteries. It may shorten the battery life, or cause the device to malfunction.
Replace the batteries two seconds or more after the device turns off.
If  (LOW BATTERY mark) appears even after the batteries are replaced, make a blood pressure measurement. The device may then recognize the new batteries.
-  (LOW BATTERY mark) does not appear when the batteries are drained.
- The battery life varies with the ambient temperature and may be shorter at low temperatures. Generally, four new LR6 batteries will last approximately for one year when used twice for measurement each day.
- Use the specified batteries only.
- Remove the batteries if the device is not to be used for a long time.
The batteries may leak and cause a malfunction.

Using the Monitor

Connecting the Air Hose

Insert the air connector plug into the air socket firmly.

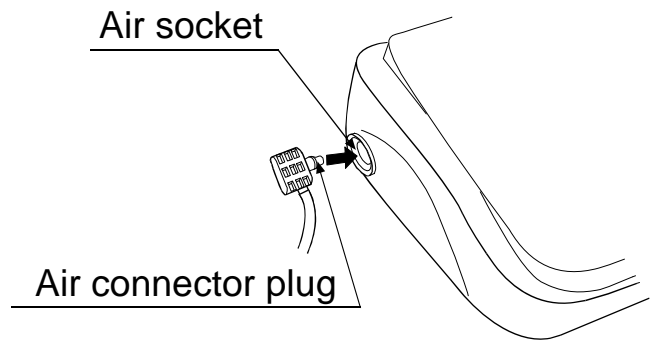

Connecting the AC Adapter

Insert the AC adapter plug into the DC jack.

Next, connect the AC adapter to an electrical outlet.

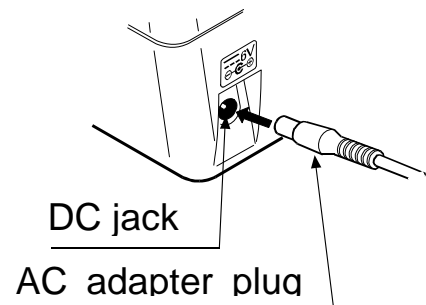

- Use the specified AC adapter.
(Refer to page 21.)
- When disconnecting the AC adapter from the electrical outlet, grasp and pull the AC adapter body out of the outlet.
- When disconnecting the AC adapter plug from the blood pressure monitor, grasp and pull the AC adapter plug out of the monitor.

Using the Monitor

Selecting the Correct Cuff Size

Using the correct cuff size is important for an accurate reading. If the cuff is not the proper size, the reading may yield an incorrect blood pressure value.

- The arm size is printed on each cuff.
- The index ▲ and proper fit range, on the cuff, tell you if you are applying the correct cuff. (Refer to "Symbols that are printed on the cuff" on the next page)
- If the index ▲ points outside of the range, contact your local dealer to purchase a replacement cuff.
- The arm cuff is a consumable. If it becomes worn, purchase a new one.

Arm Size	Recommended Cuff Size	Catalog Number
31 cm to 45 cm	Large Adult Cuff	CUF-F-LA
22 cm to 42 cm	Wide Range Cuff	CUF-I
22 cm to 32 cm	Adult Cuff	CUF-F-A

Arm size: The circumference at the biceps.

Note: Model UA-767S is not designed for using a small cuff.

Applying the Arm Cuff

1. Wrap the cuff around the upper arm, about 1-2 cm above the inside of the elbow, as shown. Place the cuff directly against the skin, as clothing may cause a faint pulse, and result in a measurement error.
2. Constriction of the upper arm, caused by tightly rolling up a shirtsleeve, may prevent accurate readings.
3. Confirm that the index ▲ points within the proper fit range.

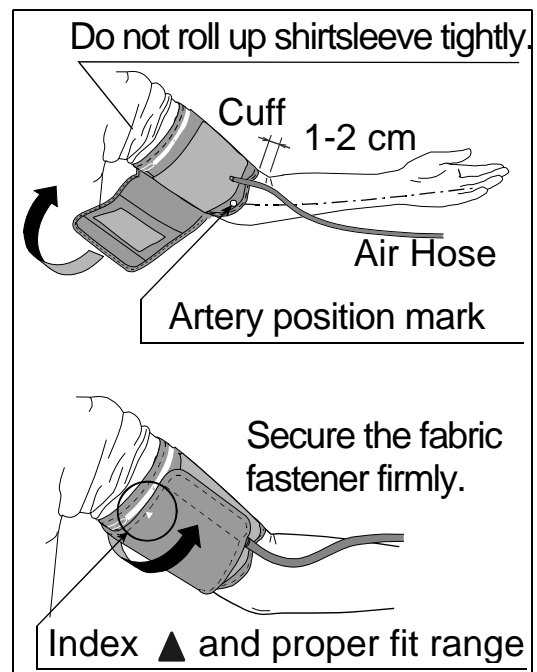

Using the Monitor

Symbols that are printed on the cuff

Symbols	Function / Meaning	Recommended Action
●	Artery position mark	Set the ● mark on the artery of the upper arm or in line with the ring finger on the inside of the arm.
▲	Index	_____
REF	Catalog number	_____
A	Proper fit range for the adult cuff. It's printed on the adult cuff.	_____
L	Range to use the large adult cuff. Over range printed on the adult cuff and wide range cuff.	Use the large adult cuff instead of the adult cuff or wide range cuff.
W	Proper fit range for the wide range cuff. It's printed on the wide range cuff.	_____
L	Proper fit range for the large adult cuff. It's printed on the large adult cuff.	_____
S	Under range printed on the adult cuff and wide range cuff.	_____
A	Range to use the adult cuff. It's printed on the large adult cuff.	Use the adult cuff instead of the large adult cuff.
LOT	Lot number	_____

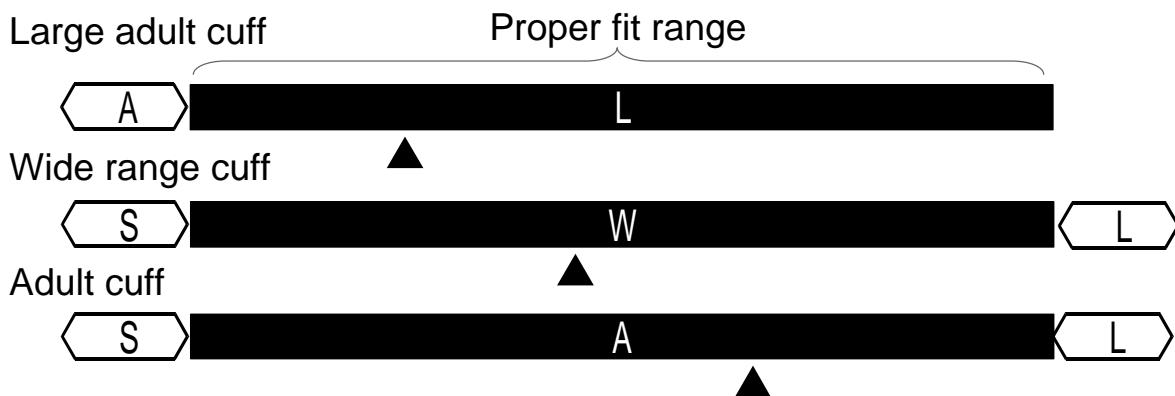

Using the Monitor

How to Take Accurate Measurements

For the most accurate blood pressure measurement:

- Sit comfortably on a chair. Rest your arm on the table. Do not cross your legs. Keep your feet on the floor and straighten your back.
- Relax for about five to ten minutes before measurement.
- Place the center of the cuff at the same height as your heart.
- Remain still and keep quiet during measurement.
- Do not measure right after physical exercise or a bath. Rest for twenty or thirty minutes before taking the measurement.
- Try to measure your blood pressure at the same time every day.

Measurement

During measurement, it is normal for the cuff to feel very tight. (Do not be alarmed).

After Measurement

After measurement, press the START button to turn the device off. After one minute of non-operation, the device will turn off automatically.

Remove the cuff and record your data.

Note: Allow at least three minutes between measurements on the same person.

Measurements

Before measurement, read “Notes for Accurate Measurement” on the next page.

Normal Measurement

1. Place the cuff on the arm (preferably the left arm).
Sit quietly during measurement.

2. Press the **START** button.
All of the display segments are displayed.
Zero (0) is displayed blinking briefly.

The display changes, as indicated in the figure at the right, as the measurement begins. The cuff starts to inflate. It is normal for the cuff to feel very tight. A pressure bar indicator is displayed, on the left edge of the display, during the inflation.

Note: If you wish to stop inflation at any time, press the **START** button again.

3. When inflation is complete, deflation starts automatically and ♥ (heart mark) blinks, indicating that the measurement is in progress. Once the pulse is detected, the mark blinks with each pulse beat.

Note: If an appropriate pressure is not obtained, the device starts to inflate again automatically. To avoid re-inflation, see “Measurement with the Desired Systolic Pressure” on the next page.

4. When the measurement is complete, the systolic and diastolic pressure readings and pulse rate are displayed.
The cuff exhausts the remaining air and deflates completely.

5. Press the **START** button to turn the device off.
After one minute of non-operation, the device will turn off automatically.

Note: Allow at least three minutes between measurements on the same person.

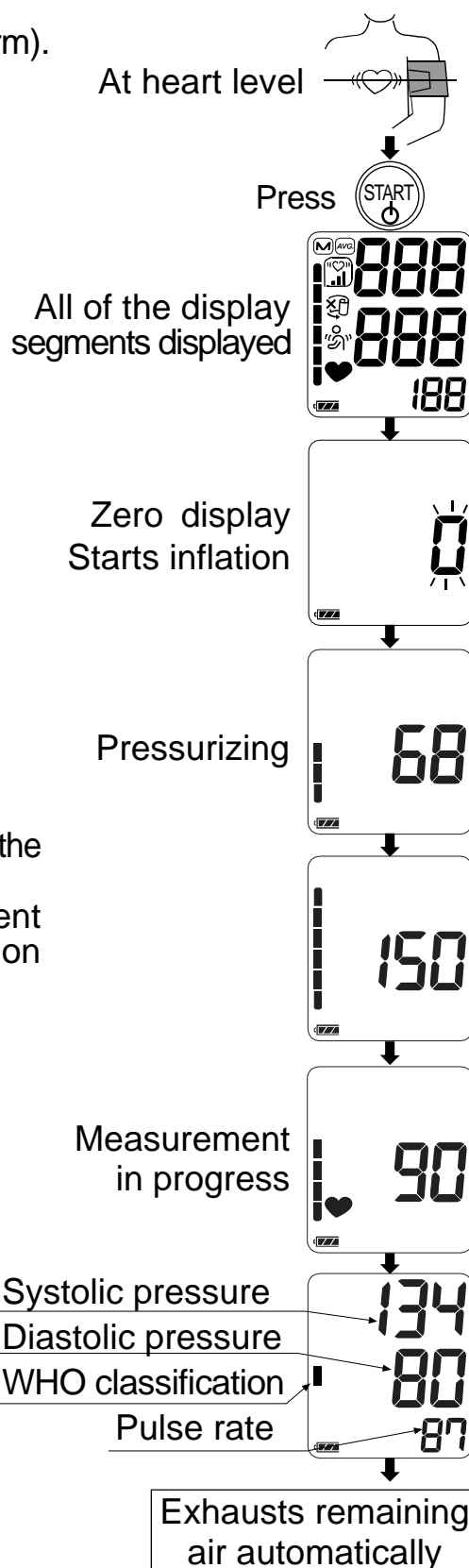

Measurements

Measurement with the Desired Systolic Pressure

Model UA-767S is designed to detect the pulse and to inflate the cuff to a systolic pressure level automatically.

Use this method when re-inflation occurs repeatedly or when the results are not displayed even if the pressure decreases to 20 mmHg or less.

1. Place the cuff on the arm at heart level (preferably the left arm).
2. Press the **START** button.
3. During the zero blinks, press and hold the **START** button until a number about 30 to 40 mmHg higher than your expected systolic pressure appears.
4. When the desired number is reached, release the **START** button to start measurement. Continue to measure your blood pressure as described on the previous page.

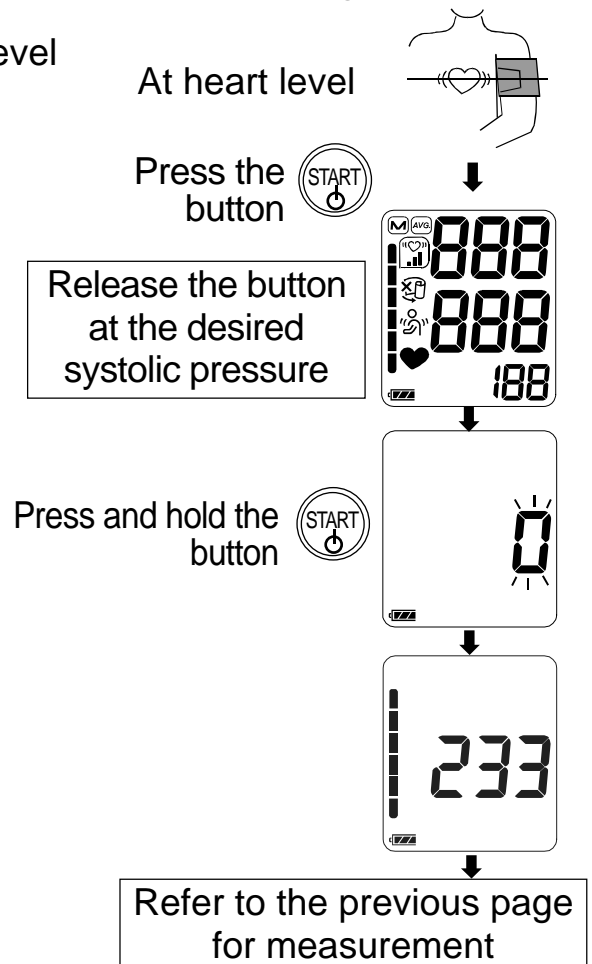

Notes for Accurate Measurement

- ❑ Sit down in a comfortable position. Place your arm on a table with your palm facing upward and the cuff at the same level as your heart.
- ❑ Relax for about five to ten minutes before taking a measurement. If you are excited or depressed by emotional stress, the measurement will reflect this stress as a higher (or lower) than normal blood pressure reading and the pulse reading will usually be faster than normal.
- ❑ An individual's blood pressure varies constantly, depending on what you are doing and what you have eaten. What you drink can have a very strong and rapid effect on your blood pressure.
- ❑ This device bases its measurements on the heartbeat. If you have a very weak or irregular heartbeat, the device may have difficulty determining your blood pressure.

- ❑ Should the device detect a condition that is abnormal, it will stop the measurement and display an error symbol. Refer to page 6 for the description of symbols.
- ❑ This blood pressure monitor is intended for use by adults only. Consult with your physician before using this device on a child. A child should not use this device unattended.

Recalling the Memory Data

Note: This device stores the last 60 measurements in memory.

1. When nothing is displayed, press and hold the **START** button to recall the stored data.
2. Release the button when displaying the average data.
3. The data number and stored data are automatically displayed in order from the last measurement.
4. The display will turn off automatically after all data is displayed.

Press and hold  button

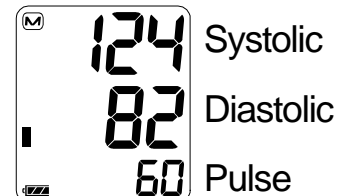
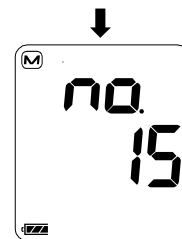
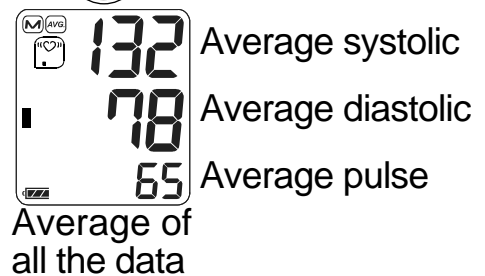

Most recent data

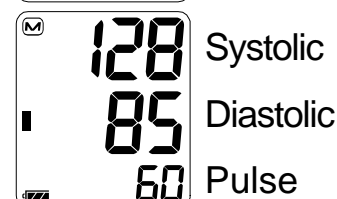
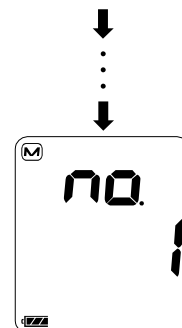

Last data (Oldest)

Note: If you press the **START** button while recalling data, the device turns off.

What is an Irregular Heartbeat

The UA-767S blood pressure monitor provides a blood pressure and pulse rate measurement even when an irregular heartbeat occurs. An irregular heartbeat is defined as a heartbeat that varies by 25% from the average of all heartbeats during the blood pressure measurement. It is important that you are relaxed, remain still and do not talk during measurements.

Note: We recommend contacting your physician if you see this «♥» indicator frequently.

%IHB

%IHB is displayed as frequency of IHB detected.

IHB can detect not only noises such as physical movement but also an irregular heartbeat. Therefore, we recommend contacting your physician if %IHB level is high.

$$\%IHB = \frac{\left(\begin{array}{c} \text{Number of detected} \\ \text{IHBs in memory} \end{array} \right)}{\left(\begin{array}{c} \text{Total number} \end{array} \right)} \times 100 [\%]$$

Display of %IHB: %IHB is displayed when displaying average values. (Refer to “2. Recalling the Data” in “Operation Mode”) %IHB is not displayed when the memory number is six or less.

Average value display

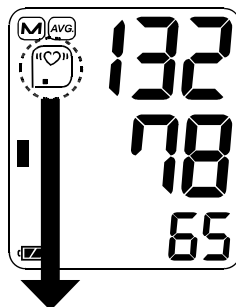

Level 0 %IHB=0~24	Level 1 %IHB=25~49	Level 2 %IHB=50~74	Level 3 %IHB=75~100
Not displayed			

Pressure Bar Indicator

The indicator monitors the progress of pressure during measurement.

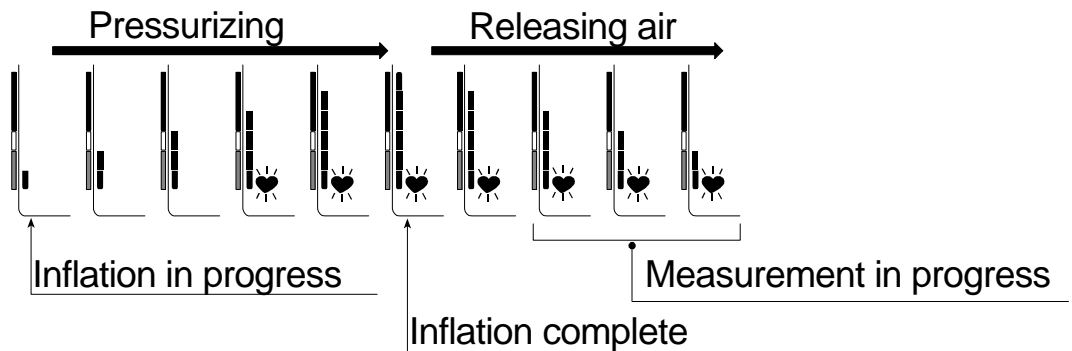

WHO Classification Indicator

Each segment of the bar indicator corresponds to the WHO blood pressure classification described on the next page.

WHO Classification Indicator

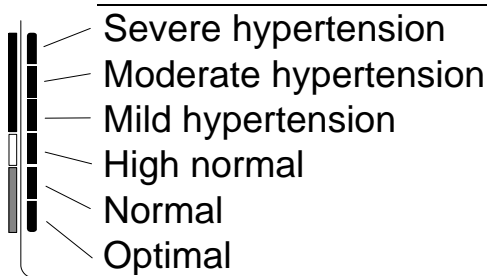

■ : The indicator displays a segment, based on the current data, corresponding to the WHO classification.

Example:

Three examples of digital blood pressure readings with corresponding WHO classification indicators:

- Reading: 174/102/87. Classification: Moderate hypertension.
- Reading: 147/98/87. Classification: Mild hypertension.
- Reading: 134/87/87. Classification: High normal.

About Blood Pressure

What is Blood Pressure?

Blood pressure is the force exerted by blood against the walls of the arteries. Systolic pressure occurs when the heart contracts. Diastolic pressure occurs when the heart expands. Blood pressure is measured in millimeters of mercury (mmHg). One's natural blood pressure is represented by the fundamental pressure, which is measured first thing in the morning while one is still at rest and before eating.

What is Hypertension and How is it Controlled?

Hypertension, an abnormally high arterial blood pressure, if left unattended, can cause many health problems including stroke and heart attack. Hypertension can be controlled by altering lifestyle, avoiding stress, and with medication under a doctor's supervision.

To prevent hypertension or keep it under control:

- Do not smoke
- Exercise regularly
- Reduce salt and fat intake
- Have regular physical checkups
- Maintain proper weight

Why Measure Blood Pressure at Home?

Blood pressure measured at a clinic or doctor's office may cause apprehension and can produce an elevated reading, 25 to 30 mmHg higher than that measured at home. Home measurement reduces the effects of outside influences on blood pressure readings, supplements the doctor's readings and provides a more accurate, complete blood pressure history.

WHO Blood Pressure Classification

Standards to assess high blood pressure, without regard to age, have been established by the World Health Organization (WHO), as shown in the chart.

Reference Material: Journal of Hypertension 1999, Vol 17 No.2

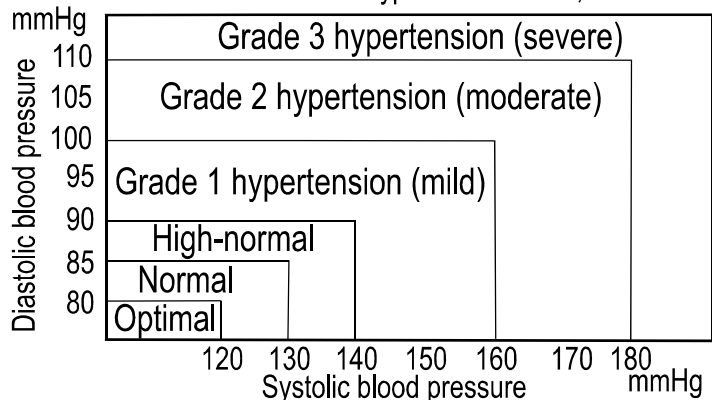

Blood Pressure Variations

An individual's blood pressure varies greatly on a daily and seasonal basis. It may vary by 30 to 50 mmHg due to various conditions during the day. In hypertensive individuals, variations are even more pronounced. Normally, the blood pressure rises while at work or play and falls to its lowest levels during sleep. So, do not be overly concerned by the results of one measurement.

Take measurements at the same time every day using the procedure described in this manual to get to know your normal blood pressure. Regular readings give a more comprehensive blood pressure history. Be sure to note the date and time when recording your blood pressure. Consult your doctor to interpret your blood pressure data.

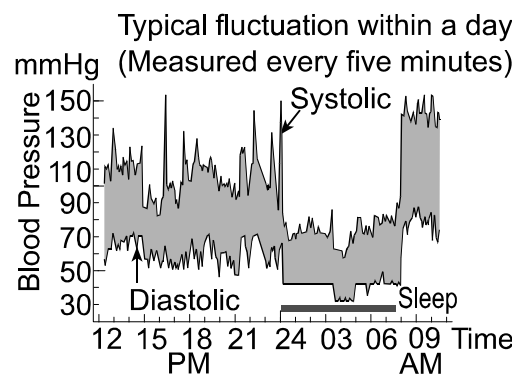

Troubleshooting

Problem	Possible Reason	Recommended Action
Nothing appears on the display, even when the power is turned on.	Batteries are drained.	Replace all batteries with new ones.
	Battery terminals are not in the correct position.	Reinstall the batteries with negative and positive terminals matching those indicated on the battery compartment.
The cuff does not inflate.	Battery voltage is too low.  (LOW BATTERY mark) blinks. If the batteries are drained completely, the mark does not appear.	Replace all batteries with new ones.
The device does not measure. Readings are too high or too low.	The cuff is not applied properly.	Apply the cuff correctly.
	You moved your arm or body during measurement.	Make sure you remain very still and quiet during measurement.
	The cuff position is not correct.	Sit comfortably and still. Place your arm on a table with your palm facing upward and the cuff at the same level as your heart.
	_____	If you have a very weak or irregular heart beat, the device may have difficulty in determining your blood pressure.
Other	The value is different from that measured at a clinic or doctor's office.	Refer to "Why Measure Blood Pressure at Home?".
	_____	Remove the batteries. Place them back properly and take another measurement.

Note: If the actions described above do not solve the problem, contact the dealer. Do not attempt to open or repair this product, as any attempt to do so will make your warranty invalid.

Maintenance

Do not open the device. It uses delicate electrical components and an intricate air unit that could be damaged. If you cannot fix the problem using the troubleshooting instructions, contact the authorized dealer in your area or our customer service department. The A&D customer service will provide technical information, spare parts and units to authorized dealers.

The device was designed and manufactured for a long service life. However it is generally recommended to have the device inspected every 2 years, to ensure proper functioning and accuracy. Please contact the authorized dealer in your area or A&D for maintenance.





Technical Data

Type	UA-767S
Measurement method	Oscillometric measurement
Measurement range	Pressure: 0 - 299 mmHg Systolic pressure: 60 - 279 mmHg Diastolic pressure: 40 - 200 mmHg Pulse: 40 - 180 beats / minute
Measurement accuracy	Pressure: ± 3 mmHg Pulse: $\pm 5\%$
Power supply	4 x 1.5V batteries (R6P, LR6 or AA) or AC adapter (TB-233) (Not included)
Number of measurements	Approx. 700 times LR6 (alkaline batteries) Approx. 200 times R6P (manganese batteries) With pressure value 180 mmHg, room temperature 23 °C.
Classification	Internally powered ME equipment (Supplied by batteries) / Class II (Supplied by adapter) Continuous operation mode
Clinical test	According to ANSI / AAMI SP-10 1992
EMC	IEC 60601-1-2: 2007
Memory	Last 60 measurements
Operating conditions	+10 to +40 °C / 15 to 85 %RH / 800 to 1060 hPa
Transport / Storage conditions	-20°C to +60°C / 10%RH to 95%RH
Dimensions	Approx. 140 [W] x 60 [H] x 105 [D] mm
Weight	Approx. 245 g, excluding the batteries
Ingress protection	Device: IP21

Applied part	Cuff	Type BF 
Useful life	Device:	5 years (when used six times a day)
	Cuff:	2 years (when used six times a day)

Accessory AC adapter

The adapter is to connect the device to a power source at home. Please contact your local A&D dealer for purchasing. The AC adapter is required to be inspected or replaced periodically.

TB-233	
TB-233C	Input: 100-240V Output: 6V  500mA  139°C 2A
TB-233BF	Input: 240V Output: 6V  500mA  139°C 2A

Accessories sold separately

Cuff	Catalog Number	Cuff Size	Arm Size
	CUF-F-LA	Large adult cuff	31 cm to 45 cm
	CUF-I	Wide range cuff	22 cm to 42 cm
	CUF-F-A	Adult cuff	22 cm to 32 cm

Arm size: The circumference at the biceps.

AC adapter

Catalog Number	Plug (Outlet type)
TB-233C	Type C
TB-233BF	Type BF

Note: Specifications are subject to change without prior notice.

EMC table information is listed on our website:

http://www.aandd.jp/products/manual/medical/emc_acadapter_en.pdf

AND

🏢 A&D Company, Limited

1-243 Asahi , Kitamoto-shi, Saitama 364-8585, JAPAN
Telephone: [81] (48) 593-1111 Fax: [81] (48) 593-1119

EC REP A&D INSTRUMENTS LIMITED

Unit 24/26 Blacklands Way, Abingdon Business Park, Abingdon, Oxfordshire OX14 1DY United Kingdom
Telephone: [44] (1235) 550420 Fax: [44] (1235) 550485

A&D ENGINEERING, INC.

1756 Automation Parkway, San Jose, California 95131, U.S.A.
Telephone: [1] (408) 263-5333 Fax: [1] (408)263-0119

A&D AUSTRALASIA PTY LTD

32 Dew Street, Thebarton, South Australia 5031, AUSTRALIA
Telephone: [61] (8) 8301-8100 Fax: [61] (8) 8352-7409